



INSTALLATION INSTRUCTIONS AND OWNER'S MANUAL

Thank you for purchasing an ACCESS Lorado roll-up cover. ACI has manufactured this roll-up cover with pride using superior quality materials and craftsmanship. With proper care, your cover will provide years of service and enjoyment.

NOTICE TO INSTALLER: It is recommended you take the time to read these instructions before installing this cover even if already familiar with the product. Often improvements are made without prior notice. Always handle cover and components with care to avoid damage. If you find a part missing or defective, or if you are having trouble installing this product, please have serial number ready (found on decal under rear bar by tailgate) and call the customer service number on the back page. **When done, these instructions and warranty information** must be given to the consumer.

NOTICE TO CONSUMER: Before using this product, read the operating instructions, maintenance and safety sections of this owners manual and save for future reference.

FOR YOUR RECORDS:

DATE PURCHASED _____

WHERE PURCHASED _____

SERIAL NUMBER _____

(Located on decal under rear bar by tailgate)

WARRANTY REGISTRATION

Promptly confirm your warranty by registering online at
www.lorado.com



Problems? Questions? Missing or Damaged Parts? Installation Questions?

Visit Us Online First! www.agricover.com/index.php/faq

INSTALLATION INSTRUCTIONS:

(NOTE: For additional installation assistance go online to lorado.com, instruction manual and click on installation video.)

PREPARATION



Unpack cover components. Clean truck box if dirty.

COMPONENTS:

- 1 driver side rail
- 1 passenger side rail
- 1 Element seal kit
- 6 clamps (long box kits 8 clamps)
- 1 left and 1 right tension adjuster with washers, nuts & bolts
- 1 pre-rolled up cover assembly

TOOLS NEEDED:

- 1 - 1/2" wrench (for rail clamps)
- 1 - Spring clamp *optional* (to hold rails in place while clamping)
- 1 - Tape measure or ruler
- 1 - Scissor
- Protective eyewear
- 2 - 9/16" wrenches

NOTE ON BED LINERS: With an under-the-rail drop in bed liner, installation is possible with minimal trim cutting of bed liner at front corner of box and back by tailgate to allow side rail to install properly. Considerable trim cutting is required with an over-the-rail drop in bed liner.

1. INSTALLING COVER SIDE RAILS

NOTE: Some installs require drilling/bolting. Those kits will contain special side rail instructions Follow those instructions for rail attachment. When done, continue with number two.

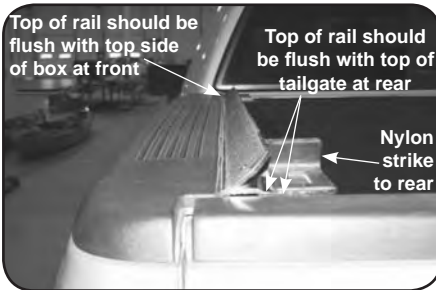

A. Position side rail with weather strip against inside lip of box. **Push rail forward until it touches front of box** (end of rail with strike goes to rear). At front, rail should be flush with top side of box. At rear rail should be flush with top of tailgate.

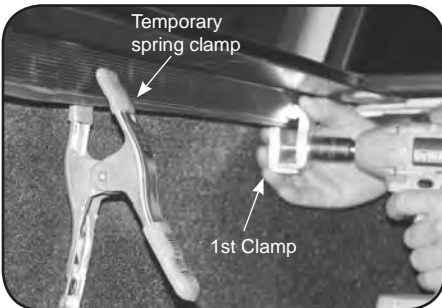

B. Hold rail in proper position with spring clamp. Install 1st clamp as close to front as possible and use 1/2" wrench to tighten.

Tip: Before using wrench on clamp, make sure clamp teeth engage grooves on rail, turn nut finger tight and then use wrench.

1. INSTALLING COVER SIDE RAILS CONTD.

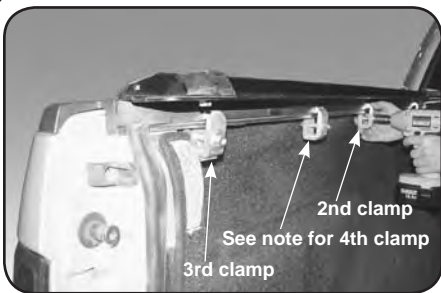

C. Install 2nd clamp on rail at midway point of box. Check if rail is level. If rail tilts up, loosen clamp, lower it and tighten. If rail tilts down, loosen clamp, raise it and tighten. Install 3rd clamp as close to tailgate as possible.

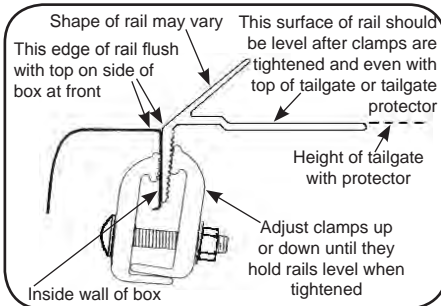

D. When done, make sure each clamp is in its best up or down position to hold rail level after tightening and that all clamps are fully tight. Repeat entire procedure for opposite side rail.

NOTE: Most short box kits contain 6 clamps. Install 3 per side rail. For kits containing 8 clamps, install 4th clamp between 2nd and 3rd clamp on each side rail. See top photo

2. APPLY ELEMENT SEAL

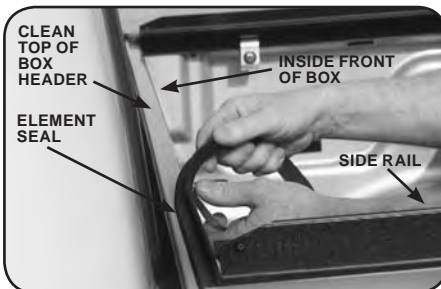

A. At front of box header, clean top surface with alcohol pad (if needed wash first).



B. Peel paper back, align and adhere Element Seal™ at one corner across box to opposite corner and cut to length.

NOTE: For additional protection—locate and seal miscellaneous factory holes, crevices, stake pockets, etc. that may be on box (sealant not included).

3. ASSEMBLING TENSION ADJUSTERS TO COVER

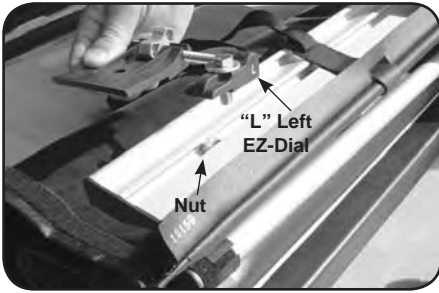

A. The cover comes pre-rolled to its normal open position for ease of installation. Set pre-rolled cover on tailgate with front bar facing up as shown. Align XT-Dial Tension Adjuster (marked L) on driver side of cover - positioned as shown in photo.



B. Turn 1-1/4" bolt with flat washer onto nut in bar. Leave loose for now. *See photo.* Repeat for XT-Dial (R) on passenger side of cover, and leave that bolt loose also.

4. MOUNTING COVER TO SIDE RAILS



A. Set rolled up cover on rails at front of box (behind cab) with bar facing up. Roll cover bar onto front of rails and fold/tuck vinyl flap under. Now bar will face down. Let straps hang to inside of box. Push cover bar forward until it sets flat on front of side rails and overhangs them.



B. Slide left tension adjuster over until it engages under side rail. Push bar back and forth to line up holes - do not turn dial wheel. Insert bolt from top and flat washer and nut from bottom.

Note: These holes are designed for a snug fit - you may need to turn the bolt through rail and adjuster with 9/16" wrench. The bolt will thread through without harming any pieces.

4. MOUNTING COVER TO SIDE RAILS CONTD.



C. Hold bolt at top and tighten nut under side rail. Repeat procedure for right hand tension adjuster.

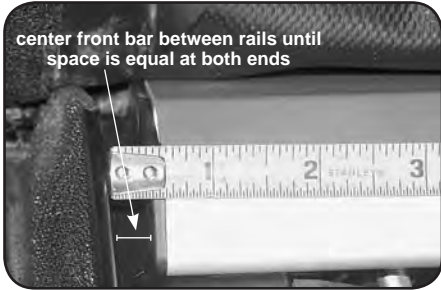

D. Center the front bar between the two side rails.



E. Then tighten bolt (left loose earlier) under front bar on each tension adjuster.

5. INITIAL OPERATION AND ADJUSTMENTS



A. Unroll cover and place rear bar into strikes on side rails and press down on bar to close (20-30 pounds pressure).



B. Close tailgate slowly - top of tailgate should fit snug under cover bar. If it is too tight - raise rails by loosening rear clamps adjust rail up and tighten clamps. If too loose adjust rails lower.



C. Check cover tension by releasing auto-latch and open and close rear bar several times. It should snap down when closing. Cover fabric should sound drumlike when tapped on. If adjustment is needed, roll cover open and **turn XT-Dial counter-clockwise to tighten, clockwise to loosen. Always turn dials in equal amounts.**



D. When done, seal both sides of cover with hook and loop system.

Note: For detailed operating instructions see page 6.

SAFETY INFORMATION

- Do not cover cargo that is higher than the cover.
- Do not place object(s) on or against the cover or its framework at any time
- Always secure cargo so it cannot shift and damage the cover or its parts.
- Do not use the covers framework to tie down cargo.
- Never stand, sit or ride on the cover or allow others to do so.
- Do not leave valuables in an unattended vehicle as cover does not prevent theft of contents in truck box.
- The cover does not eliminate moisture and dust from entering the truck box. Special wrappings or packaging of the contents may be necessary.
- Due to poor ventilation, if you allow a pet/animal in the box, leave cover open. Do not allow people or animals to occupy box with the cover closed.
- When towing vehicle backwards, cover must be rolled fully open and secured with safety straps or fully closed and secured with manual slide lock.
- ALWAYS finish securing the cover. Use caution when operating cover in windy conditions.
- Periodically check and/or retighten clamp bolts as needed.
- Periodically check and/or retighten front bar tensioning bolts as needed.

OPERATING INSTRUCTIONS

Note: view opening and closing demonstration video on www.lorado.com

TO CLOSE



Release retainer straps at front and using both hands roll cover out to rear of box.



Position roll-up bar against strikes. Push down on bar until autolatch locks in place.



Now along side of box, seal cover edges with hook and loop sealing system the full length of cover on both sides. Pull with one hand - seal with other hand.

TO OPEN



Open tailgate on driver side, pull autolatch and lift up on rear roll bar.



Using both hands, roll cover toward front of box (not against the cab).



Securely fasten retainer straps to store the cover.

OPTIONAL USE



Manual Slide Lock (use is optional) is located under cover bar on passenger side - push slide lock to engage, pull to disengage.

TIPS FOR A LONGER LASTING COVER

- Always keep cover closed when not in use.
- Keep hook and loop sealed when cover is closed.
- Keep the cover tight, cover vinyl should sound drum-like when tapped on.
- Engage manually operated slide lock while traveling and before entering automatic drive-through car washes.
- Avoid storing cover in its rolled-up position for long periods of time.
- When cleaning, for best results use mild liquid soap and water. Never clean with petroleum or citrus based products.
- Periodically treat cover with our Formula 2 cleaner instead of petroleum based products that may dry out and damage the vinyl.
- Avoid allowing cargo to rub against cover while transporting, whether in open or closed position.

TROUBLESHOOTING

PROBLEM

SOLUTION

Cover too loose	Turn both tension adjusters counter clockwise to move front bar forward. (Refer to #5C, see arrows next to adjuster)
Cover too tight	Turn both tension adjusters clockwise to move front bar rearward. (Refer to #5C, see arrows next to adjuster)
Gap between roll-up bar and tailgate	Rails set too high (Refer to #5B)
Cover is too wide	Check rails. Rails in - too wide - push all clamps to top of rail.
Cover is too narrow	Rails out - too narrow - pull all clamps down on rail (Refer to #1D)
Lopsided cover too much on one side	Check front bar. It must be centered side to side (Refer to #4D)
Top of tailgate hits rear bar when attempting to close	Raise side rails at rear of box until tailgate closes without pushing rear bar up. (Refer to #5B)
Auto latch doesn't engage	Check side rails for height and level. Inspect latch for jammed or broken parts. (Refer to #1D)
Manual slide locks too loose or too tight	Use 1/8" allen wrench and adjust set screw tighter or looser as desired. Lock performs best with some friction.

INSPECTION AND MAINTENANCE

- Inspection and much of the maintenance can be done by the operator. It may be necessary to review the installation and operating instructions.
- Periodically inspect the cover assembly and the condition of all parts. Check for loose bolts and parts and tighten if needed. Test the operation to ensure that the parts are functioning properly and that the cover is in top operational condition.
- If latch has been damaged replace with new one. NOTE: Inspection and/or maintenance should also be performed anytime a malfunction is observed or suspected. If you need assistance inspecting and/or servicing your cover, or if you want to order a replacement part, call the customer service number on the back page. Always use original equipment replacement parts for your cover.
- Vinyl cover can be treated with water base vinyl protectants. Avoid silicon base products.
- When cleaning, for best results use mild liquid soap and water. Never clean with petroleum or citrus based products.

PARTS DIAGRAM

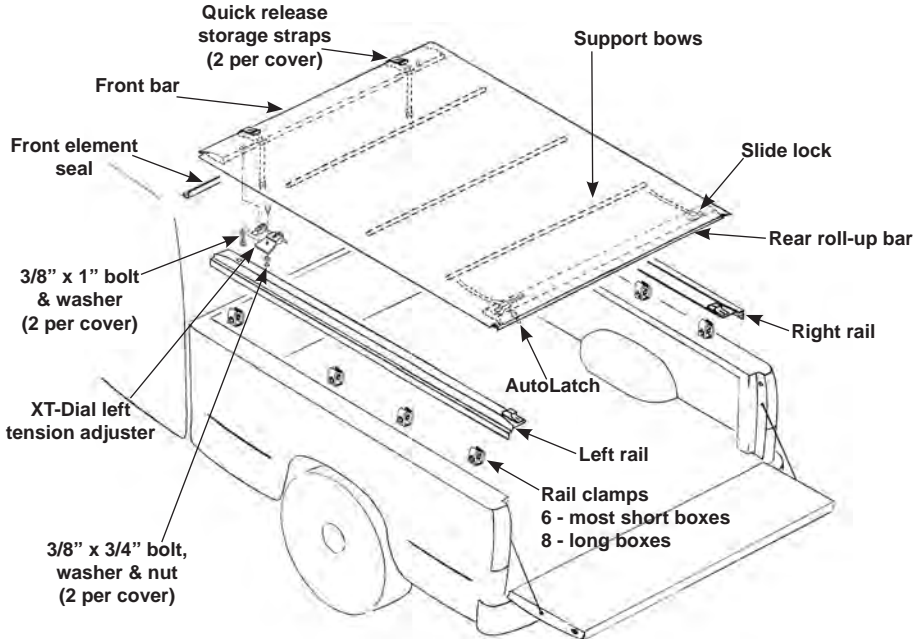

MANUFACTURER'S PREMIUM COVER™ LIMITED WARRANTY

Agri-Cover, Inc. extends the following warranty to the original retail purchaser of any ACCESS Lorado Roll-Up Cover:

Agri-Cover, Inc. warrants its ACCESS Lorado roll-up cover to be free from defects in material and workmanship, as long as the original purchaser owns the truck on which the cover was originally installed and as long as the cover remains continuously installed on said truck.

Agri-Cover, Inc.'s sole obligation under this warranty is limited to the repair or replacement, at its option, of defective parts only. No labor or service allowance is given or implied. **IN NO EVENT SHALL AGRICOVER, INC. BE LIABLE FOR INCIDENTAL, CONSEQUENTIAL, OR SPECIAL DAMAGES. AGRICOVER, INC. EXPRESSLY DISCLAIMS ANY AND ALL IMPLIED WARRANTIES OF MERCHANTABILITY, AND THERE ARE NO WARRANTIES WHICH EXTEND BEYOND THE LIMITED WARRANTY DESCRIPTION CONTAINED HEREIN.**

For warranty performance, call our Customer Service Department at 701-251-1427 to determine if only a replacement part is needed or if the cover needs to be returned for inspection and repair. **Warranty registration must be on file and/or proof of original purchase (detailed and dated receipt) required for warranty to be effective. Goods to be returned must have a pre-authorized RA # (Returned Authorization Number) - obtained by calling the number above.** Mark the number on the package and ship it freight prepaid to address below. Agri-Cover, Inc. will pay freight to return goods to sender.

This warranty does not cover any damage due to accident, abuse, misuse, alteration, neglect, improper installation, or ordinary wear and tear.

This warranty gives you specific legal rights and you may have other rights, which vary, from state to state.



Agri-Cover, Inc.
Customer Service Dept
3000 Hwy 281 SE
PO Box 508
Jamestown, ND 58402
Phone: 701-251-1427

ACCESS - A Division of Agri-Cover, Inc.

ACCESS Lorado is a United States trademark of AGRICOVER, INC.

U.S. Patent Nos. 6,543,835; 6,672,644; 6,851,738; 7,048,227;
7,008,000; 7,104,586; 7,066,524; 7,472,941; 7,621,582 and other patents pending.

**PHONE 701-251-1427 7:30 am - 5:30 pm Central Standard Time
Monday thru Friday except Holidays**

You May Also Be Interested In Our SnowSport Utility Plows

3 DISTINCT MODELS TO CHOOSE FROM



- Simple bolt on install, mounts in minutes
- No electric or hydraulic components to freeze or malfunction
- Won't scratch concrete or pavers, remove gravel or turf
- Easy storage between snowfalls or during off season
- Made model specific for your application
- Fits trucks, suvs, atvs, utvs, zero turn mowers and more

RUST RESISTANT BLADE



Heavy duty, corrosion-resistant, anodized aluminum blade repels rust, so it never needs painting.

TURF FRIENDLY



Built in trip edge won't scratch concrete, brick or black top, tear up grass surfaces or remove gravel.

NO EXTRA LIGHTS



The practical design does not block headlights in plow or transport position.

EASY TO LIFT



Our plows are easily lifted by one person. Lower the blade, plow until finished, then lift the blade back to transport position.

Call or go online to get yours today!

HOW THE SNOWSPORT PLOWS OPERATE

LIFT BLADE



To begin plowing, remove pin, lift blade one end at a time and lower it over push frame, then replace the pin.

DRIVE FORWARD

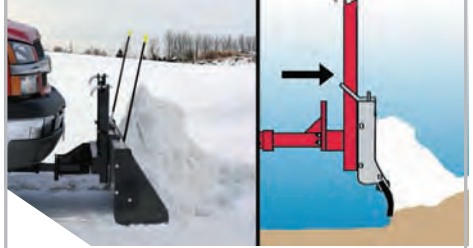

The blade is guided by a push frame that allows it to slide up and down with the grade of the terrain.

BACK UP

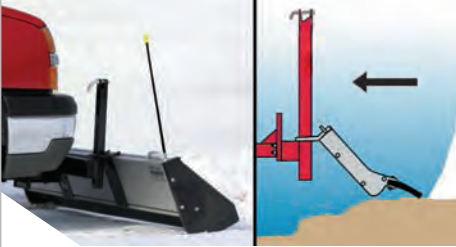

When backing up, the blade lies back, skimming over the ground. When driving forward, blade automatically re-engages for plowing. All you do is drive.

LIFT BLADE WHEN DONE



When finished plowing simply remove pins and lift one end at a time into holders and secure with pins. It's that easy!

"I love this plow! First thing I'm asked is does it work? And then, where did you get this? We get some crazy weather here in Michigan, we can get snow every day and sometimes we get snow all at once, this plow handled all of my conditions wonderfully. Once my neighbors saw that this plow did not ruin the grass or move away all of the stones on the driveway, I was asked if I could plow their areas."

Bob Werbrouck
Fenton, MI

"My first use of the Snow Sport 180 came after a 14" snow fall. It worked Great! It took about 20 minutes to get the hang of driving backwards and pushing snow but after that I have recommended to friends and co-workers to check them out. Took an hour to plow what would have taken me 4-5 hours to blow with a 10 hp snow blower. Great product!"

Barry R Bender
Dillsburg, PA

"I bought the 6 ft plow for my 2009 Yamaha Rhino 450 and one word - Awesome!! I am critical of any product but this one is up to snuff. Performs just like described and better."

Doug Parks
Cambridge, MD

866-799-2519

mysnowsport.com

Check out our Accessory Products

The perfect complement to your roll-up cover purchase.

Access™ EZ-Retriever®



Easily grab items that slid to the front of your truck bed from driving.

Works great for pushing items to the front of the truck bed.

Extends to 5' 9". Easily adjusts to the perfect length for any size bed.

Access™ TrailSeal® Tailgate Gasket



Seals gaps around the perimeter of the tailgate.

Prevents dust, rain and snow from entering through the tailgate.

The tailgate does not tightly seal without Access™ TrailSeal®.

Access® Truck Bed Pockets HD



6" tall diamond tread, aircraft grade aluminum.

Allows you to store gear at the rear of the truck bed.

Allows full space between wheel wells.

Access™ Total Bed Seal



Seals gaps in the box of 07-10 GM/ Chevy new body truck beds.

Prevents dust, rain and snow from entering the truck bed.

The kit works with tonneaus, toppers and lids.

Access® Truck Bed Pockets G2



5" tall, galvanized with a smooth, polished finish.

Creates extra storage from wasted space.

Provides easy accessibility to cargo at the rear of the truck bed.

Formula 2 Tonneau Cleaner



Water-based spray cleaner that conditions, cleans, and protects.

20 oz. plastic spray bottle.

No oily mess and no destructive silicone.

Access Cargo Management HD & G2

Access® Truck Bed Pockets and Access™ EZ-Retriever® combined in one Cargo Management Kit.

Prevents items from sliding to the front of the bed.

Available in both Access® Truck Bed Pockets HD and G2.



Get Yours Today!

866-799-2519

accesscover.com