



### Page 2 – Continued...

#### 6 OPTION 1 – Self Tapping Screws: (Easiest Installation)

Use this method if you do not plan on taking your slide bracket out often.

**Warning:** Before drilling into the truck bed make sure the area where you are going to drill through is clear of any electrical wiring, fuel lines, tanks, and reservoirs. You will have to look under the vehicle to make sure there are no obstructions at the hole locations.

- A Place bracket in the proper position and line up with marks (determined in Steps 4 and 5).
- B Adjust the Adjustable Feet (N) on the bottom of the Channels (B) so the bracket is flush with the surface the Tote will be rolling on. (Note: You may not need to use the Adjustable Feet (N). In most cases, the Adjustable Feet will not be needed in a pickup bed installation. You will only need to use the Adjustable Feet if it's necessary to raise or adjust the height of the Tote Slide Bracket.)
- C Place a Washer – Flat 1/4" (H) on each of the Self Tapping Screws – 1/4" x 2-1/2" (F) (Screws look like they have a drill bit on the end). Insert the Screws through slots in the base plate. Make sure to place Screws in the flat area of the truck bed, not on a sloped surface. Install the bracket using a cordless drill and 3/8" Socket.

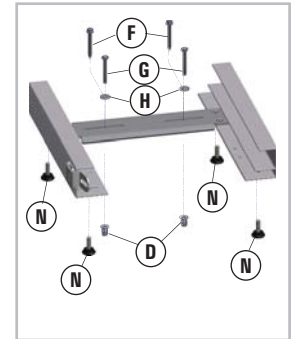

#### 7 OPTION 2 – Jack-Nuts:

Use this method if you intend to remove the slide bracket often.

**Warning:** Before drilling into the truck bed make sure the area where you are going to drill through is clear of any electrical wiring, fuel lines, tanks, and reservoirs. You will have to look under the vehicle to make sure there are no obstructions at the hole locations.

- A With the bracket in the proper position (lined up with the marks made in Step 5), mark hole locations for the Jack-Nuts-M6 (D) between the slots in the base plate, using a marker or pencil, making sure the marks are located on the flat part of the truck bed and not on a sloped surface.
- B At each mark drill a 7/16" diameter hole. (You may have to remove the bed liner or mat.)
- C Prior to installing the Jack-Nut-M6 (D) use a small phillips screwdriver and hold the Jack-Nut with a pliers. Using the screwdriver, make a hole through the rubber on the Jack-Nut. Next insert the Bolt-Hex Head M6 x 65 (G) through the hole in the Jack-Nut Friction Wrench and thread all the way into the Jack-Nut-M6 (D). Place the Jack-Nut-M6 (D) in the drilled hole (may need a hammer to tap into hole). Secure the Jack-Nut to the vehicle by tightening the Bolt-Hex Head M6 x 65 (G) using a 10mm Socket, press firmly on the Jack-Nut Friction Wrench and tighten Jack-Nut until you see the rubber on the Jack-Nut starting to get squished. Do not over tighten (max torque = 41 in/lbs). Remove the bolt from the Jack-Nut-M6 (D). Repeat this procedure for the other Jack-Nut. Note: Jack-Nut Friction Wrench is only used to install Jack-Nuts. It does not take a lot of torque to break a Jack-Nut so it is best to use a 10mm Socket and Wrench. If using a drill, be very careful not to over tighten and strip out the Jack-Nut.
- D Place the Tote Slide Bracket into position in the vehicle. Adjust the Adjustable Feet (N) on the bottom of the Channels (B) so the bracket is flush with the surface the Tote will be rolling on. (Note: You may not need to use the Adjustable Feet (N). In most cases, the Adjustable Feet will not be needed in a pickup bed installation. You will only need to use the Adjustable Feet if it's necessary to raise or adjust the height of the Tote Slide Bracket.)
- E Insert two Bolts – Hex Head M6 x 65 (G) with two Washers – Flat 1/4" (H) through the slots in the Base Plate (A) and thread them into the Jack Nuts-M6 (D). DO NOT cross-thread (make sure Bolt-Hex Head M6 x 65 (G) threads into Jack-Nut-M6 (D) properly and the threads are not misaligned). Adjust the Tote Slide Bracket to the desired position. Tighten bolts using Socket – 10mm, but do not over tighten (max torque = 41 in/lbs).

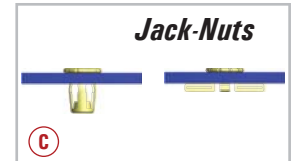

#### 8

Place the Tote into the Tote Slide Bracket to make sure the Tote slides in and out of the vehicle properly. If necessary, adjust the (N) Adjustable Feet to raise or lower the Tote Slide Bracket.

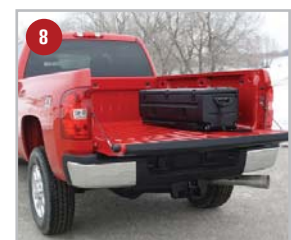

#### Important:

If you remove the Tote Slide Bracket, you must put the Bolts – Hex Head M6 x 65 (G) and Washers – Flat 1/4" (H) back into the Jack-Nuts (D) and tighten. Do not over tighten.

#### Safety Instructions:

**Warning:** Make sure the Tote lid is closed and latched and the Tote and Tote Slide Bracket are secured in the vehicle according to the installation instructions while the vehicle is moving.

Do not store explosives or hazardous materials in the Tote. Do not place loaded guns in the Tote.

### Tote Slide Bracket

### SUV

Fits DU-HA Tote Part Number: 70103

#### Tools Needed:

- // Allen Wrench – 5/32"                      // Drill    // Straight Edge
- // Socket – 8mm & 10mm                    // 5/16" & 7/16" Drill Bits                  // Hammer
- // Socket – 3/8" & 7/16"                      // Pliers    // Nail or Sharp Punch
- // Phillips Screwdriver – #3                // Marker or Pencil                            // Jack-Nut Friction Wrench (supplied)

#### Installation Instructions:

The Tote may be placed on either side of the rear cargo area of the vehicle. It is recommended that the lid open towards the outside of the vehicle for ease of access inside the Tote.

- 1** On the end of the Tote that will face the rear of the vehicle, attach one Stopper (I) to the Tote in each corner with Bolt – 1/4" x 3/4" (J) and attach Lock Swivel (M) in desired corner, as pictured.
- 2** Attach the Base Plate (A) to each Channel (B) with two Screws – Flat Head 1/4" x 1/2" (C) using an Allen Wrench – 5/32". Insert the four Adjustable Feet (N) into the pre-drilled holes in the bottom of each Channel (B).
- 3** Attach the Lock Latch (K) in the pre-drilled holes on the side of the Channel (B) with two Screws – #8 x 5/16" (L) using the Phillips Screwdriver. *(Note: Make sure the location of the Lock Latch (K) corresponds with the Lock Swivel (M) you attached to the Tote in Step 1.)*
- 4** Place the Tote and Base Plate (A) with Channels (B) into the vehicle in desired location. Slide the Tote into the Base Plate (A) with Channels (B) until the Stoppers (I) contact the Channels. *Note: Make sure the Lock Latch (K) and the Lock Swivel (M) are aligned and function properly. Make sure the Tote is positioned properly and the rear door of the vehicle closes without contacting the Tote. It is recommended to have at least 1" clearance in between the Tote and the rear door.*
- 5** Make marks at the location of the Base Plate (A), as pictured, using a marker or pencil. Hold the bracket firmly in place and remove the Tote. Note: Back of bracket should be 3" from trim piece.
- 6** **If you have a SUV that has a rear floor compartment, the bracket can be attached to the removable floor panel.** *If you do not have this compartment proceed to Step 7. Continued on Page 2.* Before drilling see **'Drill Warning'** on page 2. Drill holes in the panel with a 5/16" drill bit in the proper location *(between marks made in the slots in the base plate – determined in Step 5)*. Attach bracket with two Bolt – Hex Head M6 x 65 (G), four Washers – Flat 1/4" (H), and two Nuts– M6 (E), as pictured, using Socket – 10mm.

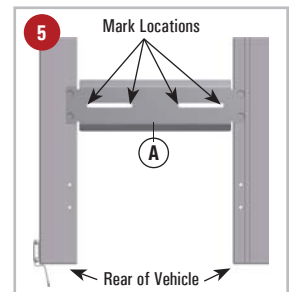
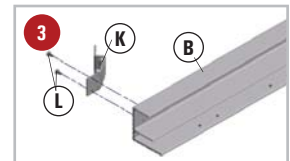
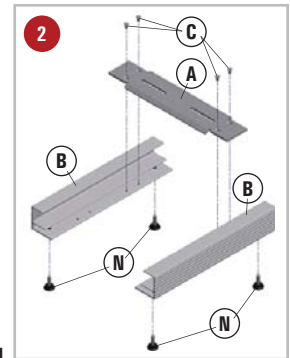
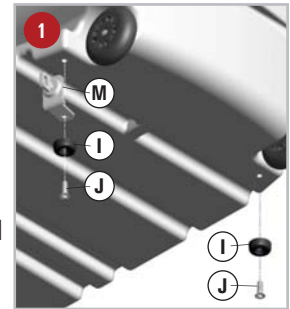

Part	Description	Qty
A	Base Plate	1
B	Channel	2
C	Screws – Flat Head 1/4" x 1/2"	4
D	Jack-Nut – M6 (1-extra)	3
E	Nut – M6	2
F	Self Tapping Screws – 1/4" x 2-1/2"	2
G	Bolt – Hex Head M6 x 65	2
H	Washers – Flat 1/4"	4
I	Stoppers	2
J	Bolt – 1/4" x 3/4"	2
K	Lock Latch	1
L	Screws – #8 x 5/16"	2
M	Lock Swivel	1
N	Adjustable Feet	4
O	Jack Nut Friction Wrench	1

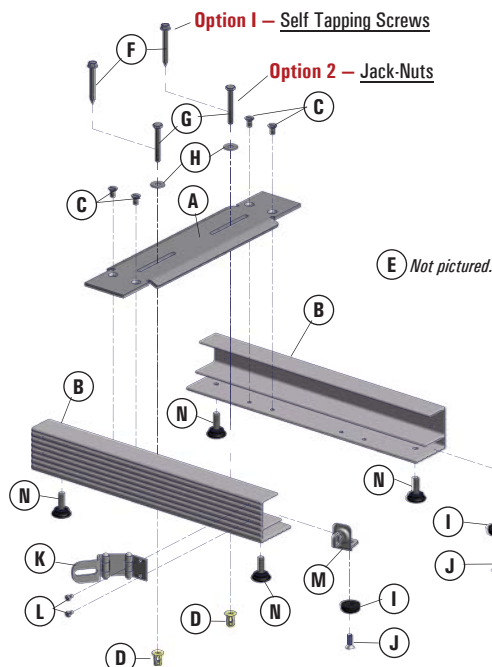



### Page 2 – Continued...

**Drill Warning:** Before drilling into the floor make sure the area where you are going to drill through is clear of any electrical wiring, fuel lines, tanks, and reservoirs. You will have to look under the vehicle to make sure there are no obstructions at the hole locations.

#### 7 OPTION 1 – Self Tapping Screws: (Easiest Installation)

**Use this method if you do not plan on taking your slide bracket out often.**

Before drilling see **'Drill Warning'** above.

- A** Place bracket in the proper position and line up with marks (determined in Steps 4 and 5).
- B** Adjust the Adjustable Feet (N) on the bottom of the Channels (B) so the bracket is flush with the surface the Tote will be rolling on. (The Tote needs to clear the trim piece to slide properly.)  
(Note: You may not need to use the Adjustable Feet (N). You will only need to use the Adjustable Feet if it's necessary to raise or adjust the height of the Tote Slide Bracket.)
- C** Place a Washer – Flat 1/4" (H) on each of the Self Tapping Screws – 1/4 x 2-1/2" (F) (Screws look like they have a drill bit on the end). Insert the Screws through the slots in the base plate. Make sure to place Screws in the flat area of the floor, not on a sloped surface. Install the bracket using a cordless drill and Socket – 3/8".

#### 8 OPTION 2 – Jack-Nuts:

**Use this method if you intend to remove the slide bracket often.**

Before drilling see **'Drill Warning'** above.

- A** Re-align the bracket to the marks made in Step 5. Make a small indentation in the floor at the outside of each slot using a hammer and a nail or sharp punch. Tap the nail or sharp punch through the carpet and insulation layers until the vehicle floor (metal) is contacted. Make sure the marks are located on the flat part of the floor and not on a sloped surface.
- B** Remove rear trim and roll back carpet and insulation to expose the marks made in Step 8A.
- C** Using a straight edge, draw a line from the left to right marks. Locate a flat point in between each set of marks, one on the right and one on the left. Drill one 7/16" hole on each flat surface on the line. Mark the hole placements onto the insulation and carpet layers and create a hole for the bolt to pass through. If using a drill and standard drill bit: (a) Drill the carpet from the underside. (b) Drill through the insulation with the drill in reverse to reduce binding.
- D** Prior to installing the Jack-Nut–M6 (D) use a small phillips screwdriver and hold the Jack-Nut with a pliers. Using the screwdriver, make a hole through the rubber on the Jack-Nut. Next insert the Bolt–Hex Head M6 x 65 (G) through the hole in the Jack-Nut Friction Wrench and thread all the way into the Jack-Nut–M6 (D). Place the Jack-Nut–M6 (D) in the drilled hole (may need a hammer to tap into hole). Secure the Jack-Nut to the vehicle by tightening the Bolt–Hex Head M6 x 65 (G) using a 10mm Socket, press firmly on the Jack-Nut Friction Wrench and tighten Jack-Nut until you see the rubber on the Jack-Nut starting to get squished. Do not over tighten (max torque = 41 in /lbs). Remove the bolt from the Jack-Nut–M6 (D). Repeat this procedure for the other Jack-Nut. **Note: Jack-Nut Friction Wrench is only used to install Jack-Nuts.** It does not take a lot of torque to break a Jack-Nut so it is best to use a 10mm Socket and Wrench. If using a drill, be very careful not to over tighten and strip out the Jack-Nut.

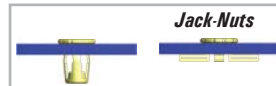

- E** Replace the carpet and insulation and snap the plastic trim pieces back into place.

- F** Place the Tote Slide Bracket into position in the vehicle. Adjust the Adjustable Feet (N) on the bottom of the Channels (B) so the bracket is flush with the plastic trim piece Tote will be rolling on. (The Tote needs to clear the trim piece to slide properly.) (Note: You may not need to use the Adjustable Feet (N). You will only need to use the Adjustable Feet if it's necessary to raise or adjust the height of the Tote Slide Bracket.)

- G** Insert two Bolts – Hex Head M6 x 65 (G) with two Washers – Flat 1/4" (H) through the slots in the Base Plate (A), carpet, and insulation, and thread them into the Jack-Nut–M6 (D). DO NOT cross-thread (make sure Bolt–Hex Head M6 x 65 (G) threads into Jack-Nut–M6 (D) properly and the threads are not misaligned). Adjust the Tote Slide Bracket to the desired position. Tighten bolts using Socket– 10mm, but do not over tighten max torque= 41 in/lbs).

- 9** Place the Tote into the Tote Slide Bracket to make sure the Tote slides in and out of the vehicle properly. If necessary, adjust the (N) Adjustable Feet to raise or lower the Tote Slide Bracket.

#### Important:

If you remove the Tote Slide Bracket, you must put the Bolts – Hex Head M6 x 65 (G) and Washers – Flat 1/4" (H) back into the Jack-Nuts – M6 (D) and tighten. Do not over tighten.

#### Safety Instructions:

**Warning:** Make sure the Tote lid is closed and latched and the Tote and Tote Slide Bracket are secured in the vehicle according to the installation instructions while the vehicle is moving. Do not store explosives or hazardous materials in the Tote. Do not place loaded guns in the Tote. For further instructions refer to the vehicle owner's manual or contact DU-HA, Inc.

