

Installation Instructions

I - Sheet Number BF39 Rev.B



Bugflector[®] - Bugflector II[®] - Carflector[®] - Chrome Hood Shield[™]

For proper installation and best possible fit, please read all instructions BEFORE you begin.
For technical assistance or to obtain missing parts, please call Customer Relations at 1-800-241-7219.

Important Safety Information



- CAUTION - Before driving, ensure that the hood shield is properly anchored to vehicle.
- Do not use automatic "brush-style" car washes.
- Do not use cleaning solvents of any kind.
- Periodically check all components for tightness.

Contents **NOTE:** Actual product may vary from illustration.



Hood Shield

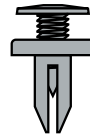

Fastener x5



Bump On x4

Tools Required



Car Wash Supplies



Clean Towel

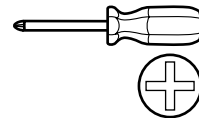

Appropriate hand tools

Preparation Before Painting / Installation

- A trial fit is recommended to ensure proper positioning and fit.
- Check fit of parts before painting as we will not accept the return of modified or painted parts.
- Wash your vehicle's hood to remove any debris and/or dirt.
- Dry the hood with a clean towel.

Installation Steps **NOTE:** Actual application may vary slightly from illustrations.

Raise the hood. Locate rubber seal and carefully remove from hood.

remove rubber seal

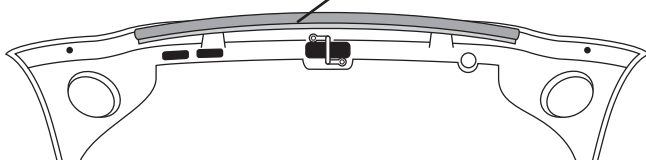

1

Set the hood shield in place.

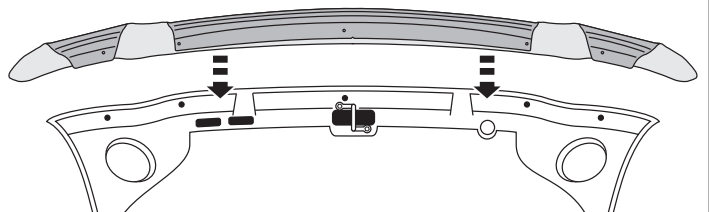

2

Installation Steps

NOTE: Actual application may vary slightly from drawings.

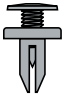

Secure the hood shield to the hood at the ends with (2) fasteners using attachment method A. Set the rubber seal back in place over the hood shield and insert the (3) remaining screw fasteners using attachment method B.

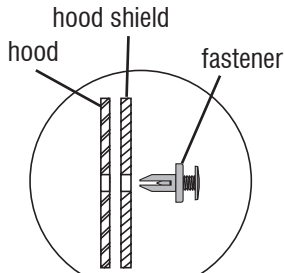
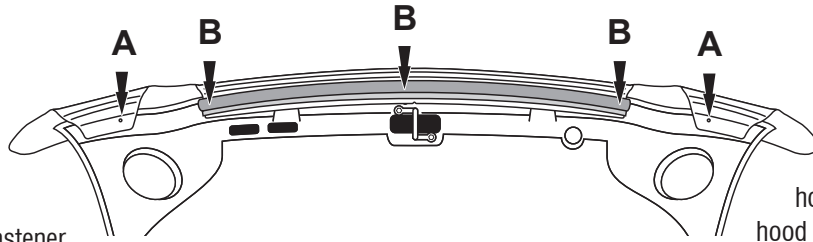
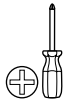

Method A

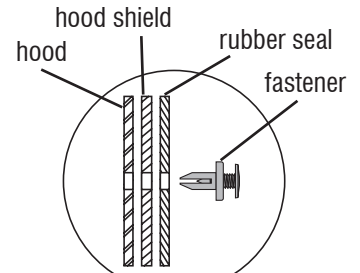

Method B

3



To reduce vibration, adhere bump-ons at precleaned locations on the hood surface where the hood shield may contact..

bump-on locations

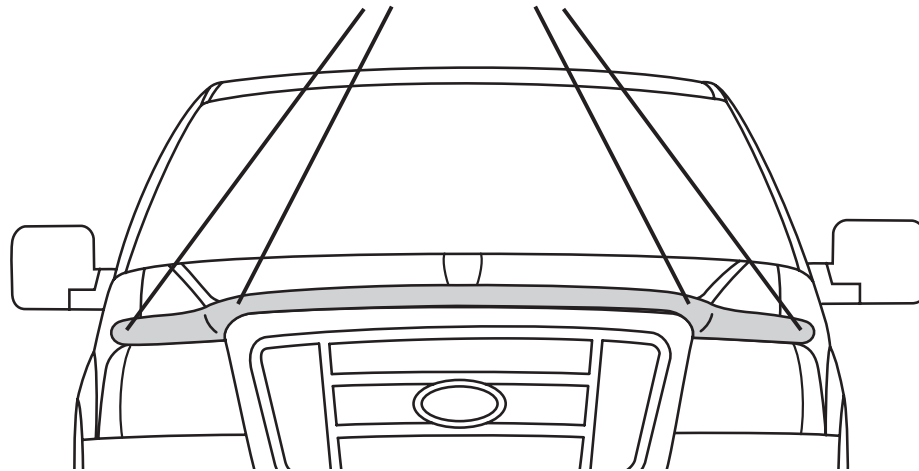

4

Care and Cleaning

- Wash only with mild soap & dry with a clean cloth.

Congratulations!

You have purchased one of the many quality Auto Ventshade™ branded products offered by Lund International, Inc. We take the utmost pride in our products and want you to enjoy years of satisfaction from your investment. We have made every effort to ensure that your product is top quality in terms of fit, durability, finish and ease of installation.



AUTO VENTSHADE™

Lund International, Ventshade Accessories Division

655 Raco Drive, Lawrenceville, GA 30045

800-241-7219 • Fax 770-339-5839 • Visit us at lundinternational.com

© 2006 Lund International, Inc. All rights reserved.



Auto Ventshade™, the Auto Ventshade™ logo, Chromelector™, and the AVS™ logo are trademarks of Lund International, Inc.



Instructions d'installation

I – Feuille numéro BF39 Rév.B



Bugflector® - Bugflector II® - Carflector® - Chrome Hood Shield™

Pour obtenir une installation correcte et le meilleur ajustement possible, lire toutes les instructions AVANT de commencer.

Pour toute assistance technique ou obtention de pièces manquantes, appeler le service des relations avec la clientèle au 1-800-241-7219.

Informations importantes concernant la sécurité



- ATTENTION - Avant de conduire, s'assurer que le pare-insectes est solidement assujéti sur le véhicule.
- Ne pas utiliser les stations de lavage de voitures à brosse.
- Ne pas utiliser de solvants.
- Vérifier régulièrement le serrage des composants..

Contenu

NOTE: Le produit réel peut changer de l'illustration.



Pare-insectes

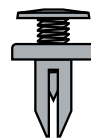

Attache (5)



Butoirs (4)

Outils nécessaires



Fournitures pour lavage de voiture



Serviette propre

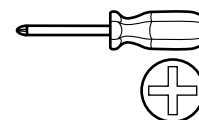

Outils à main appropriés

Préparation pour la peinture/l'installation

- Il est recommandé de procéder à un essai pour s'assurer que le positionnement et l'ajustement sont corrects.
- Vérifier l'ajustement des pièces avant peinture, car nous n'acceptons pas le retour de pièces modifiées ou peintes.
- Laver le véhicule pour éliminer toute poussière et tous débris.
- Sécher le capot avec une serviette propre.

Étapes d'installation

REMARQUE : La méthode d'application peut être légèrement différente de celle représentée par les illustrations.

Ouvrir le capot. Localiser le joint en caoutchouc et le retirer avec précaution du capot.

Retirer le joint en caoutchouc.

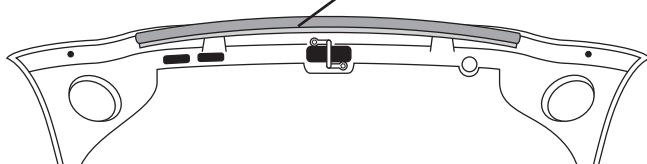

1

Mettre le pare-insectes en place.

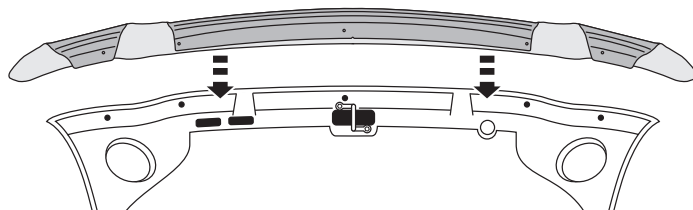

2

Étapes d'installation

REMARQUE : La méthode d'application peut être légèrement différente de celle représentée par les illustrations.



Fixer le pare-insectes au capot aux extrémités à l'aide de (2) fixations, en suivant la méthode A de fixation. Remettre le joint en caoutchouc en place sur le pare-insectes et insérer les (3) vis de fixation restantes, en suivant la méthode B de fixation.

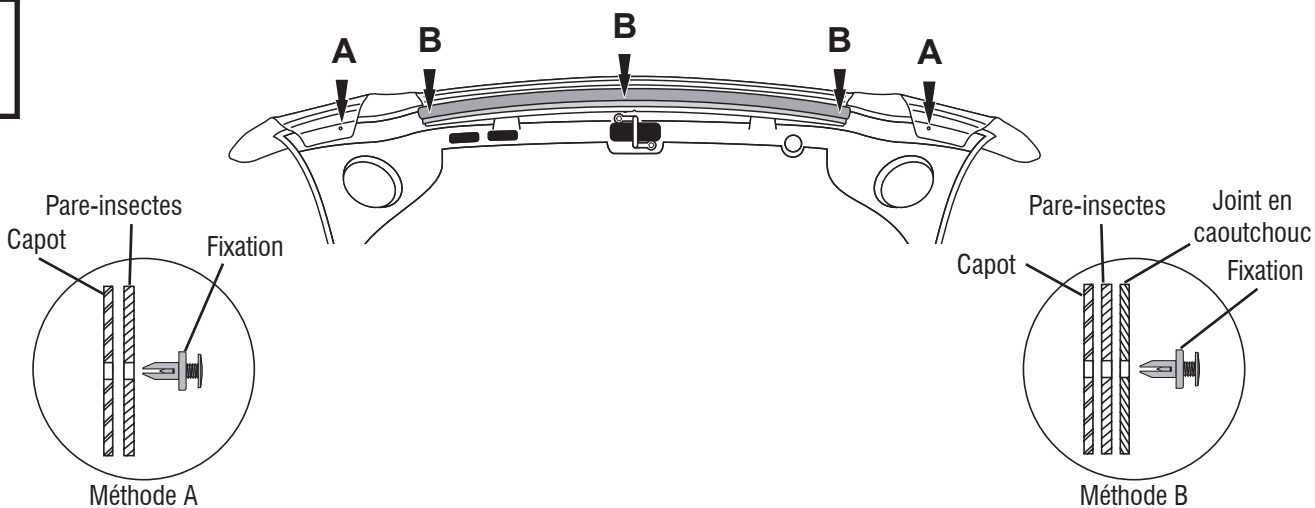

3



Pour réduire les vibrations, coller des butoirs aux emplacement prénettoyés de la surface du capot, là où le pare-insectes pourrait entrer en contact.

Emplacements des butoirs

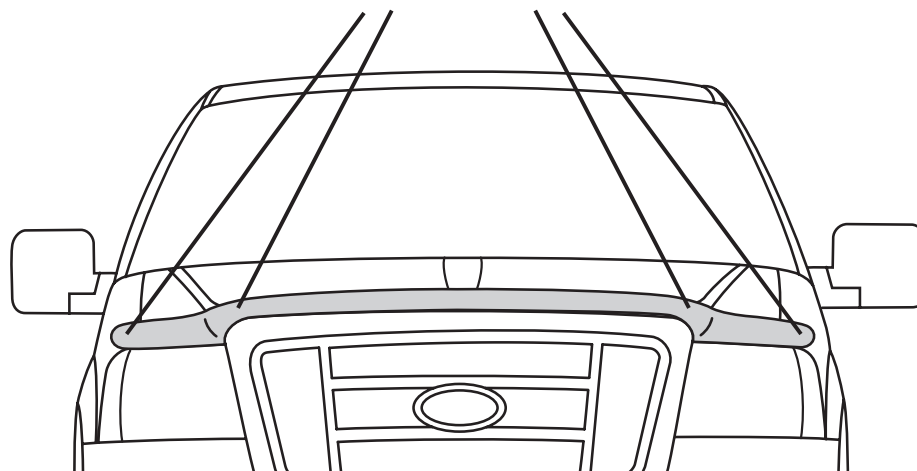

4

Entretien et nettoyage

- Laver exclusivement avec de l'eau savonneuse et sécher avec un chiffon propre.

Félicitations !

Vous avez acheté l'un des nombreux produits de qualité Auto Ventshade™ fabriqués par Lund International, Inc. Nous sommes extrêmement fiers de nos produits et souhaitons que vous tiriez des années de satisfaction de votre investissement. Nous avons pris toutes les mesures nécessaires pour assurer que ce produit est d'une qualité supérieure en ce qui concerne l'ajustement, la durabilité, la finition et la facilité d'installation.



AUTO VENTSHADE™

Lund International, Ventshade Accessories Division
655 Raco Drive, Lawrenceville, GA 30045, USA

800-241-7219 • Fax 770-339-5839 • Visitez notre site lundinternational.com

© 2006 Lund International, Inc. Tous droits réservés.



Auto Ventshade™ le logo Auto Ventshade™, Chromeflector™ et le logo AVS™ sont des marques déposées de Lund International, Inc.





Bugflector® - Bugflector II® - Carflector® - Chrome Hood Shield™

Para una instalación adecuada y el mejor ajuste posible, lea todas las instrucciones ANTES de comenzar. Si desea recibir asistencia técnica u obtener piezas faltantes, llame al Servicio al cliente al 1-800-241-7219.

Información importante de seguridad



- PRECAUCIÓN - Antes de conducir, asegúrese de que la cubierta para capó esté correctamente anclada al vehículo.
- No utilice servicios automáticos de limpieza de vehículos que utilizan cepillos.
- No utilice limpiadores al solvente de ningún tipo.
- Compruebe periódicamente que todos los componentes estén ajustados.

Contenido **NOTA:** El producto real puede variar de la ilustración.



Cubierta para capó

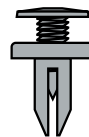

Sujetador x 5



Soporte x 4

Herramientas necesarias



Equipo de limpieza de vehículos



Toalla limpia

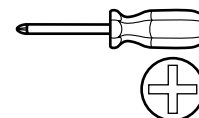

Herramientas manuales adecuadas

Preparación antes de pintar o instalar

- Se recomienda realizar un ajuste de prueba para asegurar el posicionamiento y ajuste correctos.
- Compruebe que las piezas se ajusten correctamente antes de pintarlas, ya que no aceptaremos la devolución de piezas modificadas o pintadas.
- Lave el capó del vehículo para quitar los desechos y la suciedad.
- Seque el capó con una toalla limpia.

Pasos de instalación **NOTA:** El uso real puede variar levemente de ilustraciones.

Levante el capó. Ubique la junta de goma y quítela cuidadosamente del capó.

quite la junta de goma

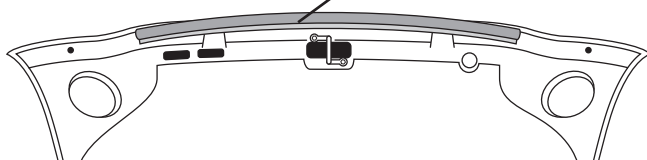

1

Coloque la cubierta para capó en su lugar.

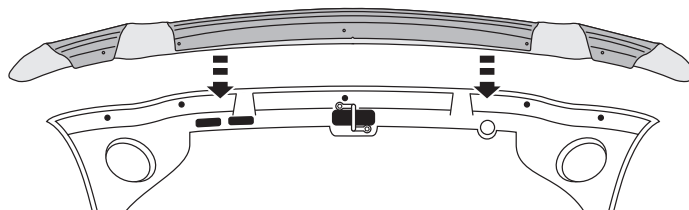

2

Pasos de instalación

AVISO: La colocación real puede variar levemente con respecto a las ilustraciones.



Asegure la cubierta para capó al capó en los extremos con (2) sujetadores mediante el método de colocación A. Coloque la junta de goma nuevamente en su lugar sobre la cubierta para capó e inserte los (3) tornillos sujetadores restantes mediante el método de colocación B.

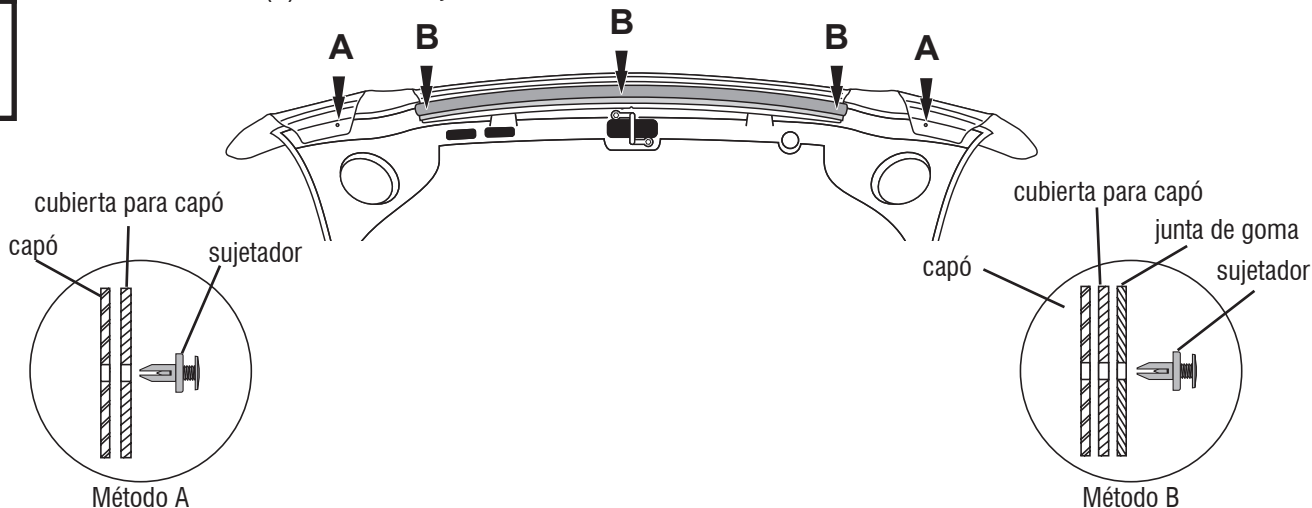

3



Para reducir la vibración, adhiera soportes en las ubicaciones que limpió previamente en la superficie del capó donde la cubierta para capó hará contacto.

ubicaciones de los soportes

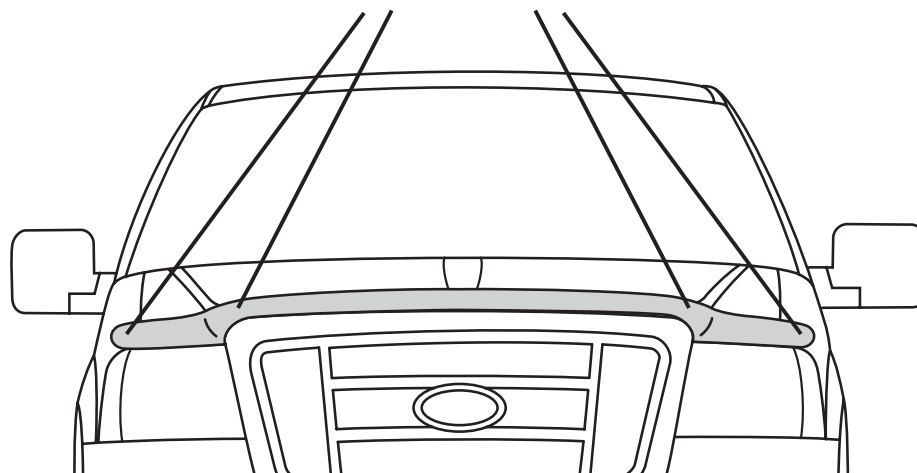

4

Cuidado y limpieza

- Limpie solamente con agua jabonosa tibia y seque con un paño limpio.

Felicidades

Usted ha comprado uno de los tantos artículos de calidad de Auto Ventshade™ ofrecidos por Lund International, Inc. Nuestros productos son nuestro mayor orgullo. Deseamos que disfrute de años de satisfacción con su inversión. Hemos realizado todos los esfuerzos para asegurarnos de que su producto sea de la mejor calidad en cuanto a ajuste, durabilidad, acabado y facilidad de instalación.



AUTO VENTSHADE™

Lund International, Ventshade Accessories Division

655 Raco Drive, Lawrenceville, GA 30045

800-241-7219 • Fax 770-339-5839 • Visite nuestro sitio Web: lundinternational.com

© 2006 Lund International, Inc. Todos los derechos reservados.



™ Auto Ventshade™ el logo de Auto Ventshade™, Chromeflector™ y el logo de AVS™ son marcas comerciales de Lund International, Inc.

