

Installation Instructions

I - Sheet Number BF107 Rev.A



Bugflector[®] - Bugflector II[®] - Carflector[®] - Chrome Hood Shield[™]

For proper installation and best possible fit, please read all instructions **BEFORE** you begin.
For technical assistance or to obtain missing parts, please call Customer Relations at 1-800-241-7219.

Important Safety Information



- CAUTION - Before driving, ensure that the hood shield is properly secured to vehicle.
- Do not use automatic "brush-style" car washes.
- Do not use cleaning solvents of any kind.
- Periodically check all components for tightness.

Contents

NOTE: Actual product may vary from illustration.



Hood shield



Fastener x2

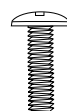

Machine Screw x2



Washer x2



Well Nut x2



Alcohol Pad



Bump On x4

Tools Required



Car Wash Supplies

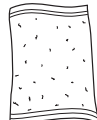

Clean Towel



Phillips screwdriver

Preparation Before Painting / Installation

- A trial fit is recommended to ensure proper positioning and fit.
- Check fit of parts before painting as we will not accept the return of modified or painted parts.
- Wash and dry your vehicle to remove any debris and/or dirt from the installation area.

Installation Steps

NOTE: Actual application may vary slightly from illustrations.

Open hood.

rubber trim piece
(if equipped)

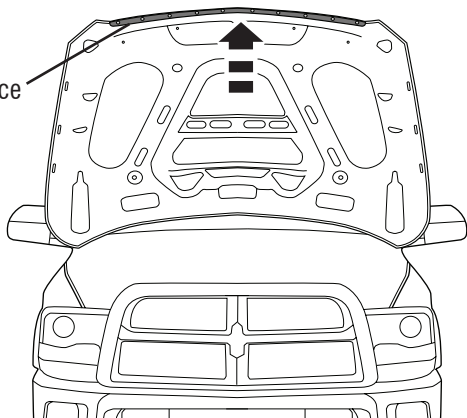

If equipped, remove and discard rubber trim piece from front edge of hood.

rubber trim piece

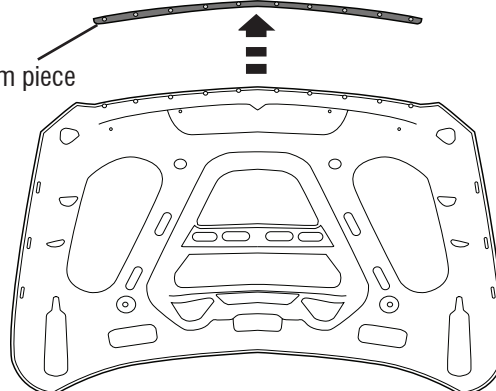

Installation Steps

NOTE: Actual application may vary slightly from illustrations.

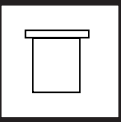

Install (2) wellnuts on hood shield flanges using (2) machine screws and (2) washers. Tighten finger tight only at this point.

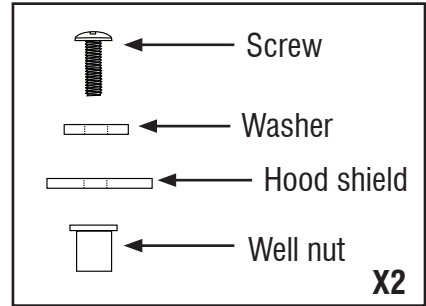
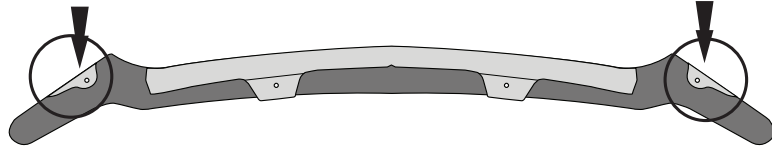

3

Align holes in hood shield with holes in hood in order to center part in place.

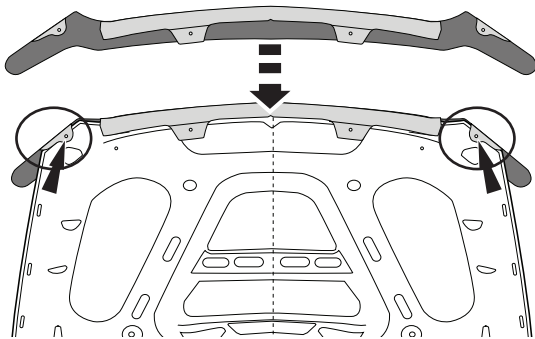

4

NOTE: observe the alignment from the side view in order to guide the hood shield with its attached well nut into the proper hole in the hood.

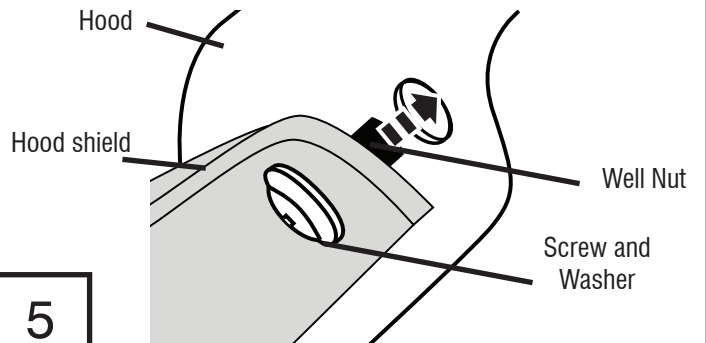

5



With the well nut inserted into hole in hood, secure hood shield to hood by tightening screw to expand well nut. Repeat for remaining fastener.

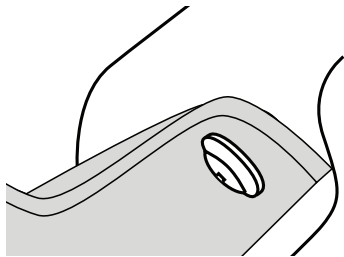

DO NOT OVER TIGHTEN

6



Insert (2) fasteners through the hood shield and into the hood and securely tighten.

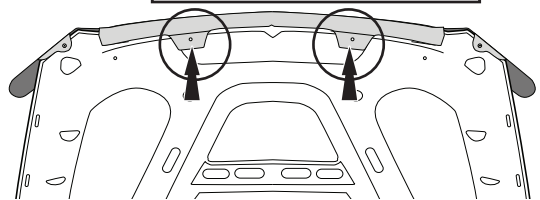
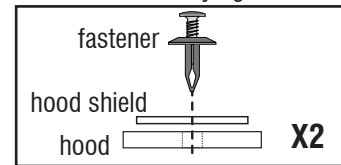
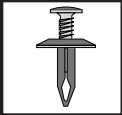

DO NOT OVER TIGHTEN

7



Close hood. Clean four (4) locations on the painted hood surface with an alcohol pad. Apply four (4) bump ons as indicated.

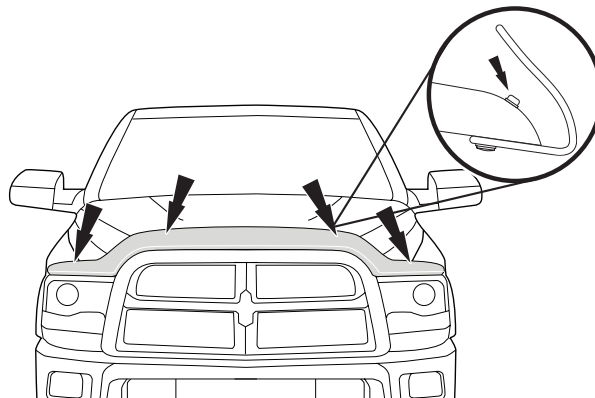

8

Care and Cleaning

- Wash only with mild soap & dry with a clean cloth.

Congratulations!

You have purchased one of the many quality Auto Ventshade™ branded products offered by Lund International, Inc. We take the utmost pride in our products and want you to enjoy years of satisfaction from your investment. We have made every effort to ensure that your product is top quality in terms of fit, durability, finish and ease of installation.



Lund International

800-241-7219 • Visit us at lundinternational.com

© 2013 Lund International, Inc. All rights reserved.



Auto Ventshade™, the Auto Ventshade™ logo and the AVS™ logo are trademarks of Lund International, Inc.





Bugflector® - Bugflector II® - Carflector® - Chrome Hood Shield™

Pour obtenir une installation correcte et le meilleur ajustement possible, lire toutes les instructions AVANT de commencer. Pour toute assistance technique ou obtention de pièces manquantes, appeler le service des relations avec la clientèle au 1-800-241-7219.

Informations importantes concernant la sécurité



- ATTENTION – Avant de conduire, s'assurer que le pare-insectes est solidement assujettie sur le véhicule.
- Ne pas utiliser les stations de lavage de voitures à brosse.
- Ne pas utiliser de solvants.
- Vérifier régulièrement le serrage des composants.

Contenu **NOTE:** Le produit réel peut changer de l'illustration.



Protection de capot



2 fixations

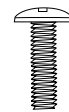

2 vis à métaux



2 rondelles



2 écrous à rivet borgnes



Tampon d'alcool



4 gommes

Outils nécessaires



Équipement de nettoyage



Linge propre



Tournevis Phillips

Préparation pour la peinture/l'installation

- Il est recommandé de procéder à un essai pour s'assurer que le positionnement et l'ajustement sont corrects.
- Vérifier l'ajustement des pièces avant peinture, car nous n'acceptons pas le retour de pièces modifiées ou peintes.
- Laver les glissières de glaces de la portière du véhicule pour éliminer toute poussière et tous débris.
- Sécher les glissières avec une serviette propre.

Étapes d'installation

REMARQUE : La méthode d'application peut être légèrement différente de celle représentée par les illustrations.

Ouvrez le capot.

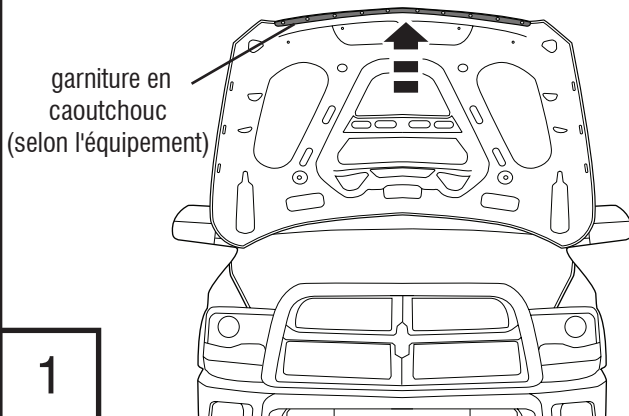

1

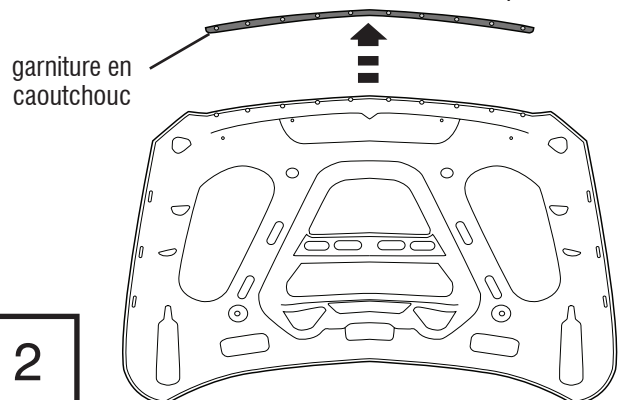

Selon l'équipement, retirez et mettez au rebut la garniture en caoutchouc du bord avant du capot.





2

Étapes d'installation

REMARQUE : La méthode d'application peut être légèrement différente de celle représentée par les illustrations.

Installez (2) écrous à rivet borgnes sur les brides de protection de capot à l'aide de (2) vis à métaux et de (2) rondelles. Ne serrez que à la main pour le moment.





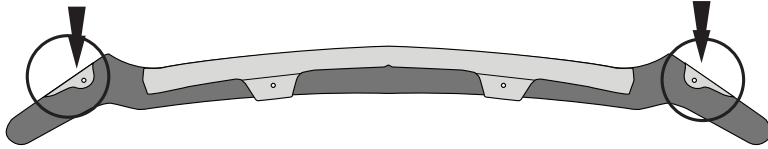

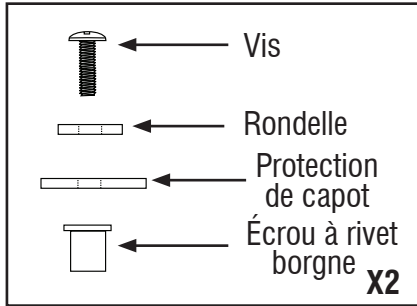

3

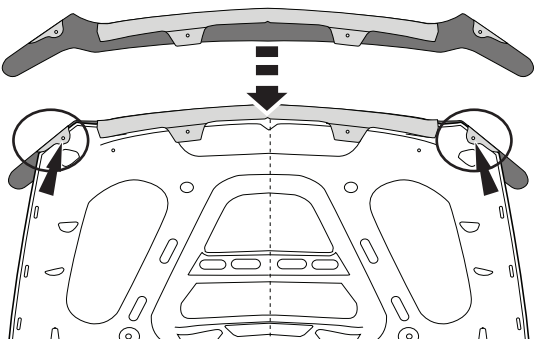
Alignez les trous dans la protection de capot avec les trous du capot de façon à centrer la pièce à la bonne place.



4

REMARQUE : respectez l'alignement ci-dessous afin de guider le protecteur de capot et son écrou à rivet borgne dans l'orifice adéquat du capot.

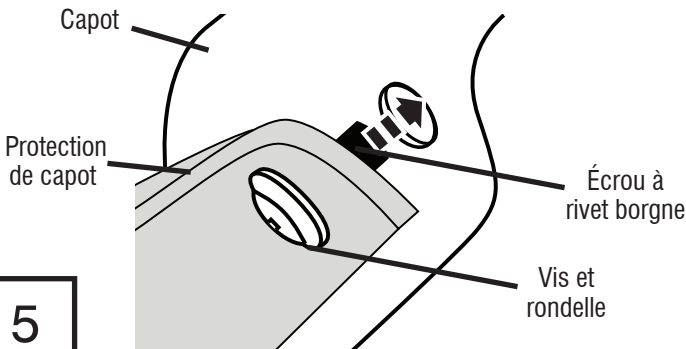

5

Une fois que l'écrou de rivet borgne est inséré dans l'orifice du capot, fixez la protection de capot en serrant la vis dans l'écrou à rivet borgne. Répétez la même procédure pour l'autre fixation.

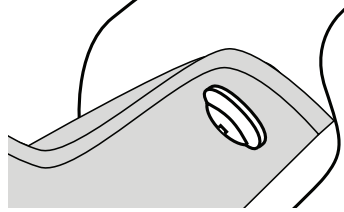

NE PAS SERRER À L'EXCÈS

6

Insérez (2) fixations à travers la protection de capot, dans le capot, puis serrez fermement.

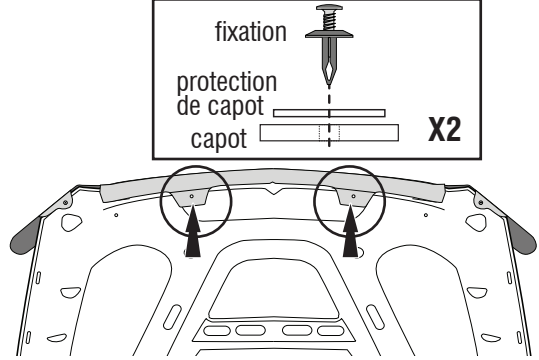

NE PAS SERRER À L'EXCÈS

7

Fermez le capot. Nettoyez quatre (4) emplacements sur la surface peinte du capot avec un tampon d'alcool. Appliquez quatre (4) gommes comme indiqué.

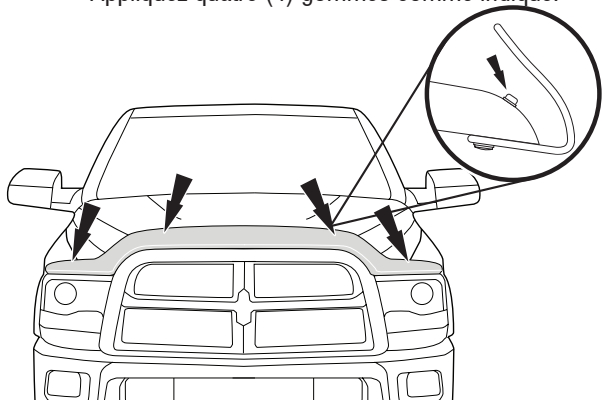

8

Entretien et nettoyage

- Laver exclusivement avec de l'eau savonneuse et sécher avec un chiffon propre.

Félicitations !

Vous avez acheté l'un des nombreux produits de qualité Auto Ventshade™ fabriqués par Lund International, Inc. Nous sommes extrêmement fiers de nos produits et souhaitons que vous tiriez des années de satisfaction de votre investissement. Nous avons pris toutes les mesures nécessaires pour assurer que ce produit est d'une qualité supérieure en ce qui concerne l'ajustement, la durabilité, la finition et la facilité d'installation.



Lund International

800-241-7219 • Visitez notre site lundinternational.com

© 2013 Lund International, Inc. Tous droits réservés.



Auto Ventshade™, le logo Auto Ventshade™ et le logo AVS™ sont des marques déposées de Lund International, Inc.



Instrucciones de instalación

Hoja informativa N.º BF107 Rev. A



Bugflector® - Bugflector II® - Carflector® - Chrome Hood Shield™

Para una instalación adecuada y el mejor ajuste posible, lea todas las instrucciones ANTES de comenzar. Si desea recibir asistencia técnica u obtener piezas faltantes, llame al Servicio al cliente al 1-800-241-7219.

Información importante de seguridad



- PRECAUCIÓN - Antes de conducir, asegúrese de que la visera deflectora esté correctamente anclada al vehículo.
- No utilice servicios automáticos de limpieza de vehículos que utilizan cepillos.
- No utilice limpiadores al solvente de ningún tipo.
- Compruebe periódicamente que todos los componentes estén ajustados.

Contenido

NOTA: El producto real puede variar de la ilustración.



Cubierta del capó

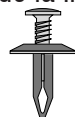

Sujetador x2

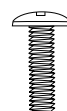

Tornillo para metales x2



Arandela x2



Remache de tuerca ciego x2



Paño con alcohol



Topes de goma x 4

Herramientas necesarias



Equipo de limpieza de vehículos



Toalla limpia



Destornillador Phillips

Preparación antes de pintar o instalar

- Se recomienda realizar un ajuste de prueba para asegurar el posicionamiento y ajuste correctos.
- Compruebe que las piezas se ajusten correctamente antes de pintarlas, ya que no aceptaremos la devolución de piezas modificadas o pintadas.
- Lave los canales de la ventanilla del vehículo para quitar los desechos y la suciedad.
- Seque los canales de la ventanilla con una toalla limpia.

Pasos de instalación

NOTA: El uso real puede variar levemente de ilustraciones.

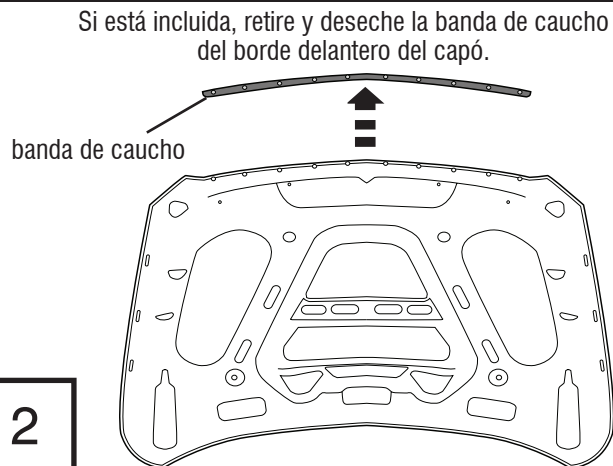
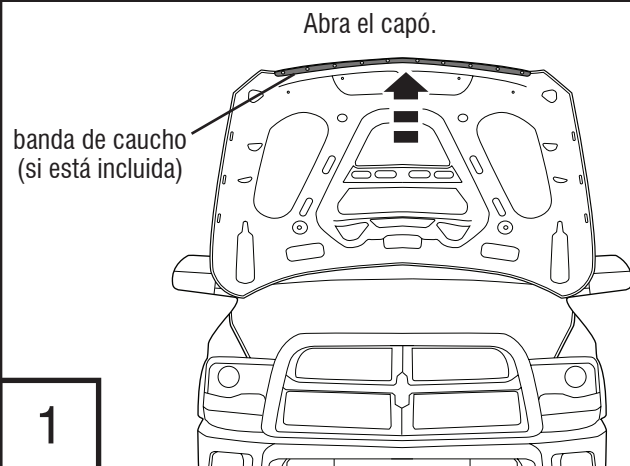

Pasos de instalación

NOTA: El uso real puede variar levemente de ilustraciones.

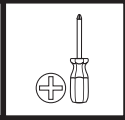
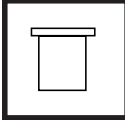

Instale (2) remaches de tuerca ciegos en los rebordes de la cubierta del capó con (2) tornillos para metales y (2) arandelas. Ajuste manualmente solo en este paso.

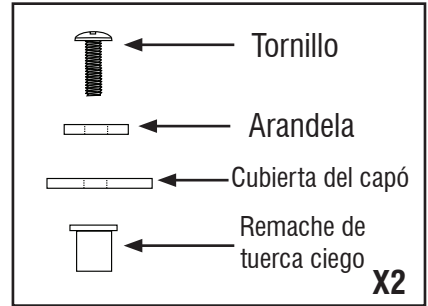
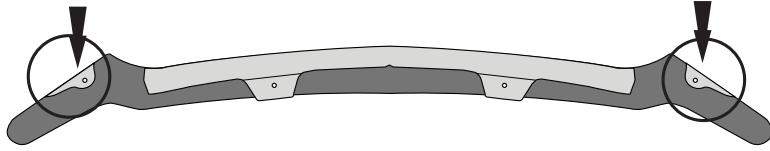
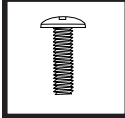

3

Alinee los orificios de la cubierta del capó con los orificios del capó para centrar la pieza en su lugar.

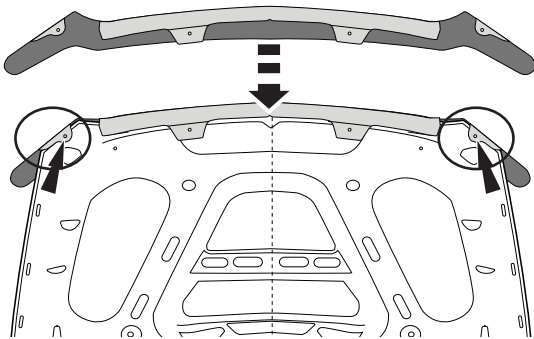

4

NOTA: Observe la alineación desde la vista lateral para orientar la cubierta del capó con su remache de tuerca ciego sujetado en el orificio apropiado del capó.

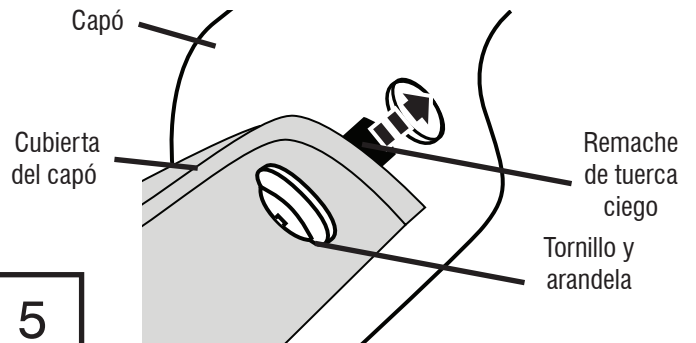

5

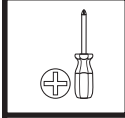

Con el remache de tuerca ciego insertado en el orificio del capó, asegure la cubierta del capó en el capó al ajustar el tornillo para expandir el remache de tuerca ciego. Repita el procedimiento con el sujetador restante.

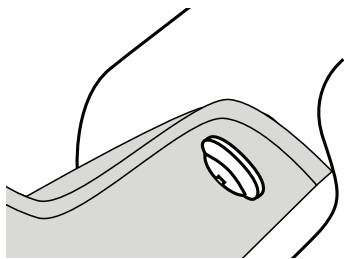

6

NO AJUSTE DEMASIADO.



Introduzca (2) sujetadores a través de la cubierta del capó y hacia adentro de este, y ajuste bien.

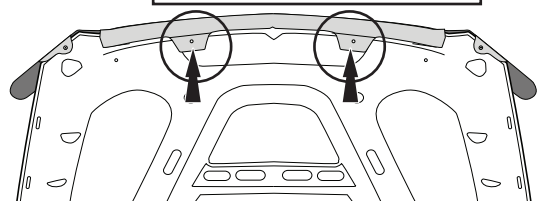
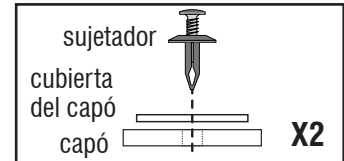

7

NO AJUSTE DEMASIADO.



Cierre el capó. Limpie los cuatro (4) puntos en la superficie pintada del capó con un paño con alcohol. Aplique cuatro (4) topes de goma como se indica.

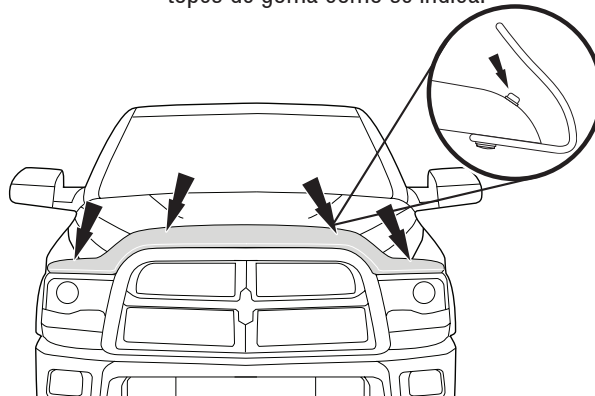

8

Cuidado y limpieza

- Limpie solamente con agua jabonosa tibia y seque con un paño limpio.

Felicidades

Usted ha comprado uno de los tantos artículos de calidad de Auto Ventshade™ ofrecidos por Lund International, Inc. Nuestros productos son nuestro mayor orgullo. Deseamos que disfrute de años de satisfacción con su inversión. Hemos realizado todos los esfuerzos para asegurarnos de que su producto sea de la mejor calidad en cuanto a ajuste, durabilidad, acabado y facilidad de instalación.



Lund International

800-241-7219 • Visite nuestro sitio Web: lundinternational.com

© 2013 Lund International, Inc. Todos los derechos reservados.



Auto Ventshade™, el logo de Auto Ventshade™ y el logo de AVS™ son marcas comerciales de Lund International, Inc.

