



Bugflector® - Bugflector II® - Carflector®

For proper installation and best possible fit, please read all instructions **BEFORE** you begin.
For technical assistance or to obtain missing parts, please call Customer Relations at 1-800-241-7219.

Important Safety Information



- CAUTION - Before driving, ensure that the hood shield is properly secured to vehicle.
- Do not use automatic "brush-style" car washes.
- Do not use cleaning solvents of any kind.
- Periodically check all components for tightness.

Contents

NOTE: Actual product may vary from illustration.

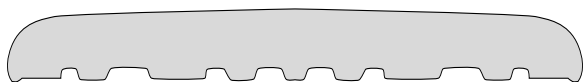

Hood shield



Fender Protector x2



Bump On x2



Screws x2

Tools Required



Car Wash Supplies



Clean Towel

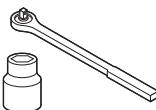

Socket Wrench

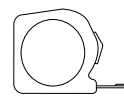

Measuring Tape

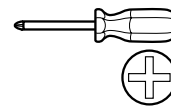

Phillips Screwdriver

Preparation Before Painting / Installation

- A trial fit is recommended to ensure proper positioning and fit.
- Check fit of parts before painting as we will not accept the return of modified or painted parts.
- Wash and dry your vehicle to remove any debris and/or dirt from the installation area.

Installation Steps

NOTE: Actual application may vary slightly from illustrations.

Open Hood.

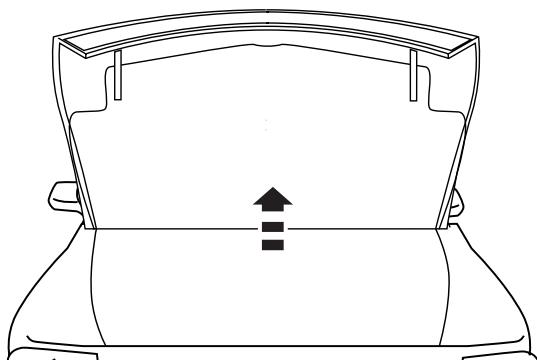

1



Locate frame that attaches to hood. Loosen, but do not remove (4) hex screws that attach to the underside of hood.

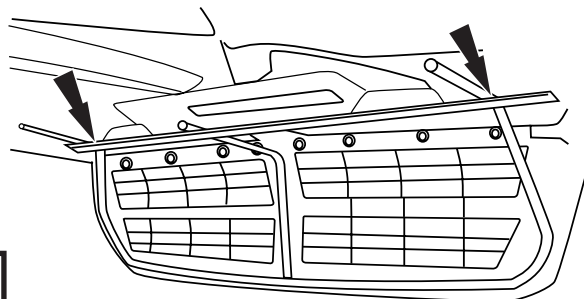

2

Installation Steps

NOTE: Actual application may vary slightly from illustrations.



Locate hex screws that the top of grill to hood. Loosen, but do not remove screws.

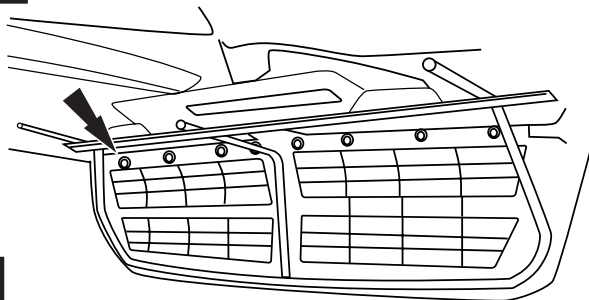

3

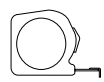

Lower hood and pivot grill forward to create a 1/8" gap between hood and grill.

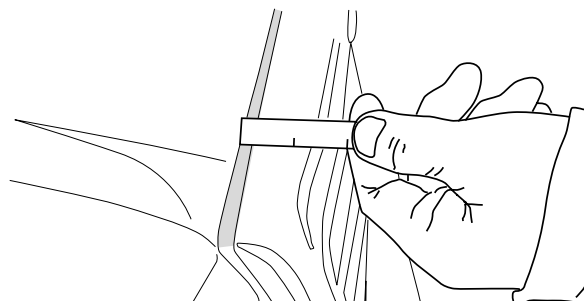

4

Slide hood shield between hood and grill until properly positioned. Retighten previously loosened hex screws.

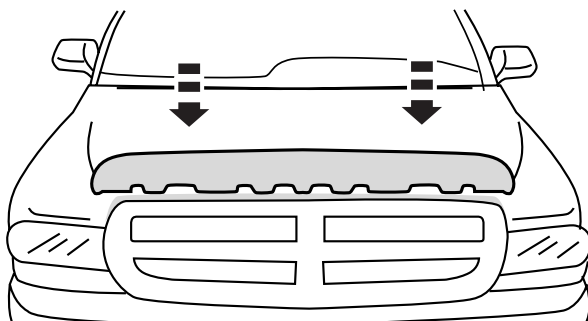

5

Fender Protector Installation

Place (1) bump on on the leading edge of fender above headlight 9" from edge of grill.

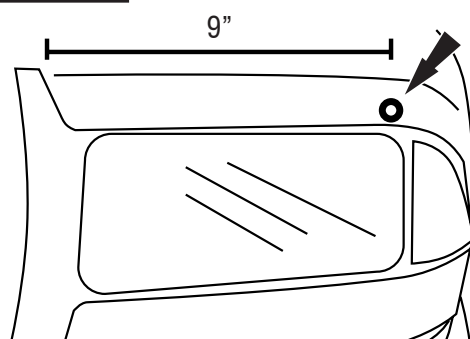

6

Expose sheet metal of hood by releasing the rubber seal near grill area. Discard plastic fastener.

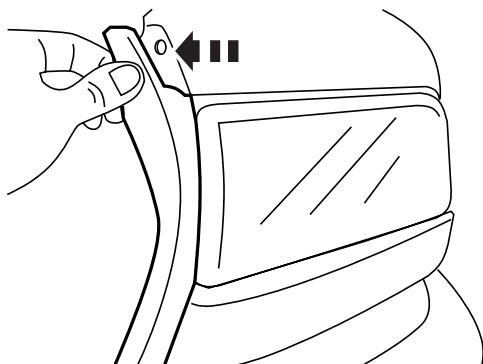

7

Slide protector tab behind main assembly by tilting while aligned with the space between the side marker and main headlight assembly.

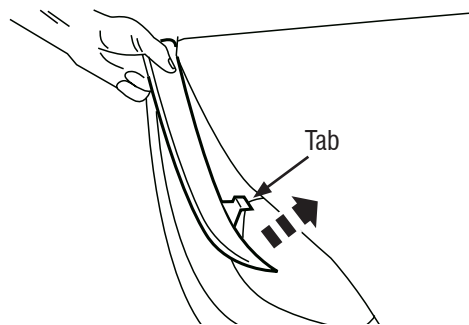

8

Align the predrilled hole in the protector with the hole in the sheet metal by sliding flange between the rubber and metal flange.

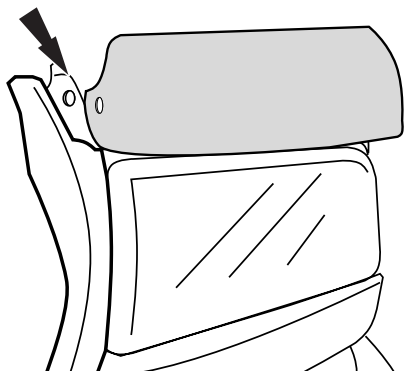

9

The self tapping screw replaces the previously discarded fastener. Secure deflector and rubber seal to sheet metal flange using this screw.

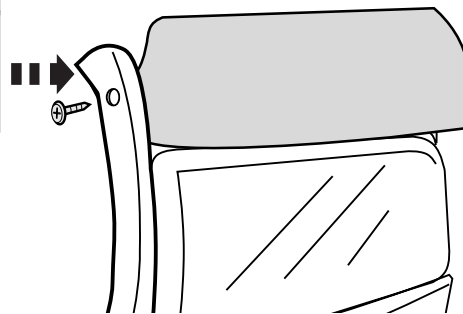
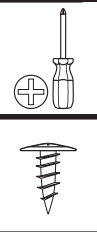

10

DO NOT OVER TIGHTEN

Installation Steps

NOTE: Actual application may vary slightly from illustrations.

Repeat for opposite side fender protector.

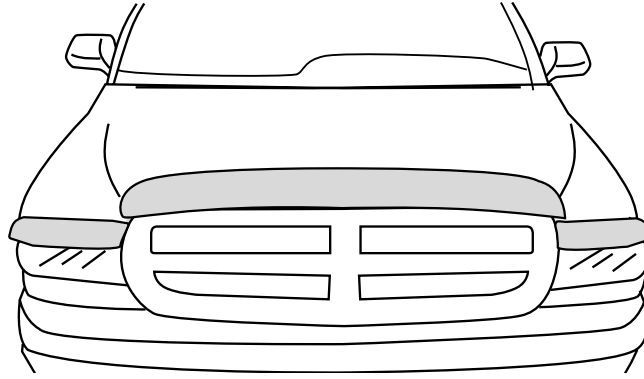

11

Care and Cleaning

- Wash only with mild soap & dry with a clean cloth.

Congratulations!

You have purchased one of the many quality Auto Ventshade™ branded products offered by Lund International, Inc. We take the utmost pride in our products and want you to enjoy years of satisfaction from your investment. We have made every effort to ensure that your product is top quality in terms of fit, durability, finish and ease of installation.



Lund International

800-241-7219 • Visit us at lundinternational.com

© 2012 Lund International, Inc. All rights reserved.

Auto Ventshade™, the Auto Ventshade™ logo and the AVS™ logo are trademarks of Lund International, Inc.





Bugflector® - Bugflector II® - Carflector®

Pour obtenir une installation correcte et le meilleur ajustement possible, lire toutes les instructions AVANT de commencer. Pour toute assistance technique ou obtention de pièces manquantes, appeler le service des relations avec la clientèle au 1-800-241-7219.

Informations importantes concernant la sécurité



- ATTENTION – Avant de conduire, s'assurer que le pare-insectes est solidement assujettie sur le véhicule.
- Ne pas utiliser les stations de lavage de voitures à brosse.
- Ne pas utiliser de solvants.
- Vérifier régulièrement le serrage des composants.

Contenu

NOTE: Le produit réel peut changer de l'illustration.



Pare-insectes



protecteur d'amortisseur (2)



Butoirs (4)



Vis taraudeuses (2)

Outils nécessaires



Fournitures pour lavage de voiture

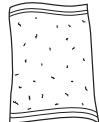

Serviette propre

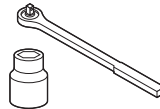

Clé à douille

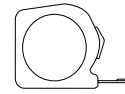

Bande De Mesure

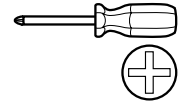

Tournevis Phillips

Préparation pour la peinture/l'installation

- Il est recommandé de procéder à un essai pour s'assurer que le positionnement et l'ajustement sont corrects.
- Vérifier l'ajustement des pièces avant peinture, car nous n'acceptons pas le retour de pièces modifiées ou peintes.
- Laver les glissières de glaces de la portière du véhicule pour éliminer toute poussière et tous débris.
- Sécher les glissières avec une serviette propre.

Étapes d'installation

REMARQUE : La méthode d'application peut être légèrement différente de celle représentée par les illustrations.

Ouvrir le capot.

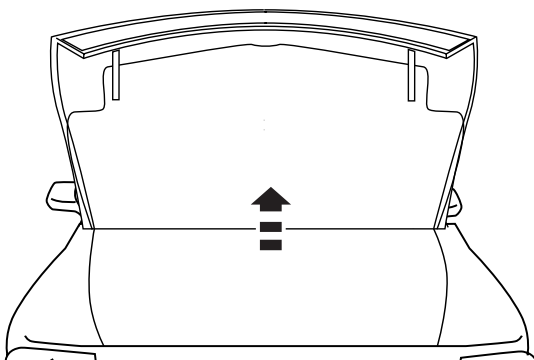

1



Localiser le cadre qui se fixe sur le capot. Desserrer sans retirer les (4) vis à tête hexagonale fixées sur le dessous du capot.

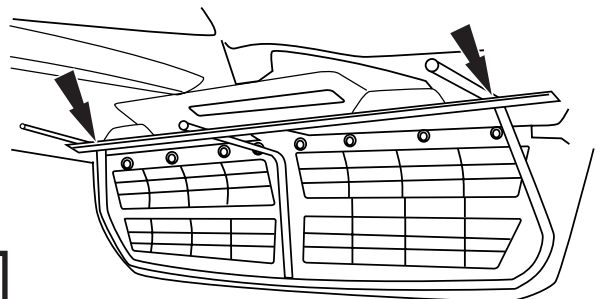

2

Étapes d'installation

REMARQUE : La méthode d'application peut être légèrement différente de celle représentée par les illustrations.



Localiser les vis à tête hexagonale qui retiennent la partie supérieure de la calandre au capot. Desserrer les vis sans les enlever.

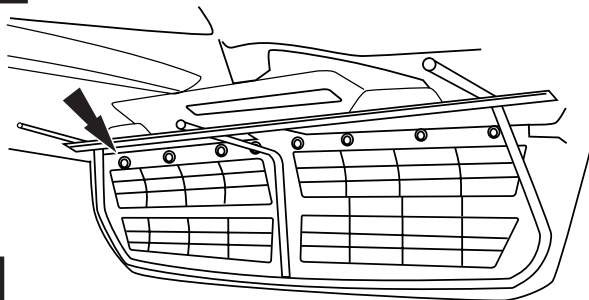

3

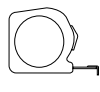

Fermer le capot et faire pivoter la calandre vers l'avant pour créer un espace de 0,32 cm (1/8 po) entre le capot et la calandre.

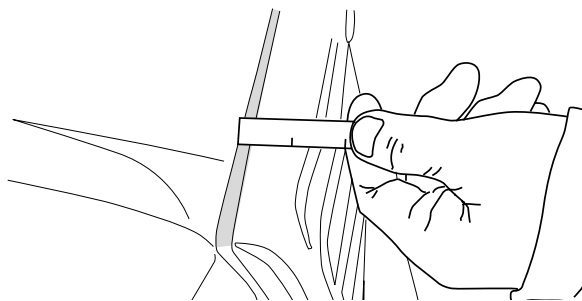

4

Faire glisser le pare-insectes entre le capot et la calandre jusqu'à ce qu'il soit bien en place. Resserrer les vis à tête hexagonale précédemment desserrées.

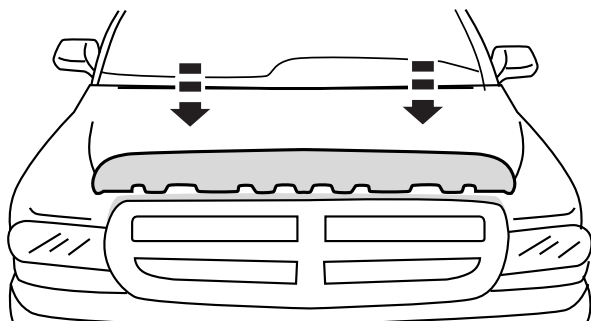

5

Installation de la protection d'aile

Placer un butoir sur le bord avant de l'aile, au-dessus du phare et à 23 cm (9 po) du rebord de la calandre.

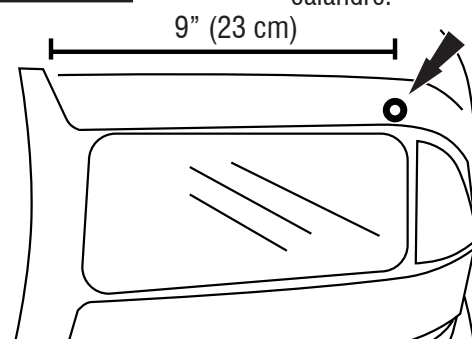

6

Exposer la tôle du capot en dégageant le joint en caoutchouc, près de la calandre. Jeter la fixation en plastique.

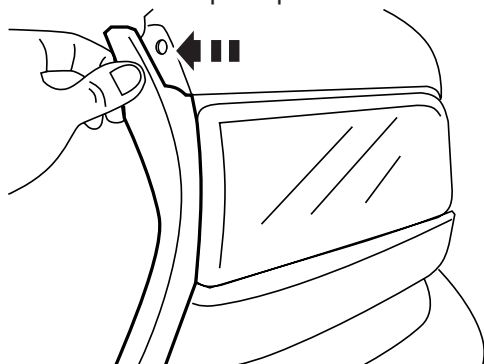

7

Faire glisser la languette de la protection derrière l'ensemble principal en l'inclinant après l'avoir alignée sur l'espacement qui sépare le feu de gabarit latéral et le phare principal.

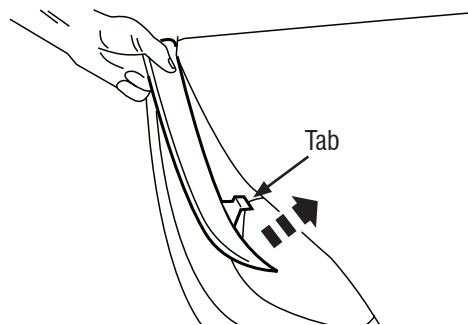

8

Aligner le trou prépercé de la protection et celui de la tôle, en faisant glisser le rebord entre le caoutchouc et le rebord métallique.

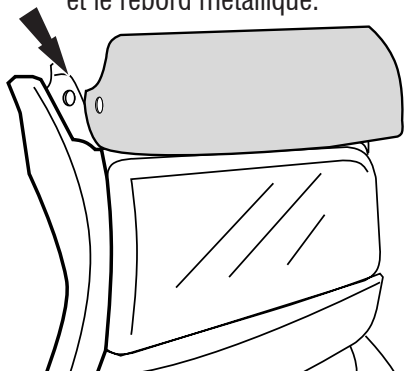

9



La vis taraudeuse remplace la fixation précédemment enlevée. À l'aide de cette vis, fixer le déflecteur et le joint en caoutchouc sur le rebord en tôle.

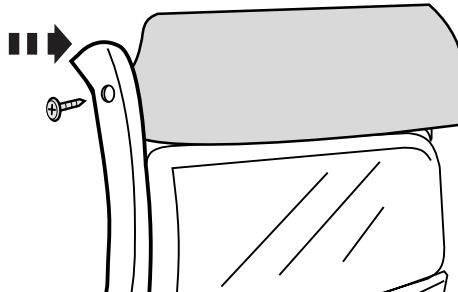

10

NE PAS TROP SERRER

Étapes d'installation

REMARQUE : La méthode d'application peut être légèrement différente de celle représentée par les illustrations.

Répéter la procédure pour la protection d'aile du côté opposé.

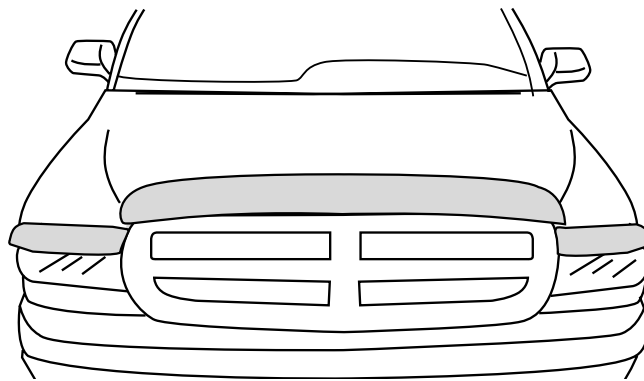

11

Entretien et nettoyage

- Laver exclusivement avec de l'eau savonneuse et sécher avec un chiffon propre.

Félicitations !

Vous avez acheté l'un des nombreux produits de qualité Auto Ventshade™ fabriqués par Lund International, Inc. Nous sommes extrêmement fiers de nos produits et souhaitons que vous tiriez des années de satisfaction de votre investissement. Nous avons pris toutes les mesures nécessaires pour assurer que ce produit est d'une qualité supérieure en ce qui concerne l'ajustement, la durabilité, la finition et la facilité d'installation.



Lund International

800-241-7219 • Visitez notre site lundinternational.com

© 2012 Lund International, Inc. Tous droits réservés.



Auto Ventshade™, le logo Auto Ventshade™ et le logo AVS™ sont des marques déposées de Lund International, Inc.





Bugflector® - Bugflector II® - Carflector®

Para una instalación adecuada y el mejor ajuste posible, lea todas las instrucciones ANTES de comenzar. Si desea recibir asistencia técnica u obtener piezas faltantes, llame al Servicio al cliente al 1-800-241-7219.

Información importante de seguridad



- PRECAUCIÓN - Antes de conducir, asegúrese de que la visera deflectora esté correctamente anclada al vehículo.
- No utilice servicios automáticos de limpieza de vehículos que utilizan cepillos.
- No utilice limpiadores al solvente de ningún tipo.
- Compruebe periódicamente que todos los componentes estén ajustados.

Contenido

NOTA: El producto real puede variar de la ilustración.

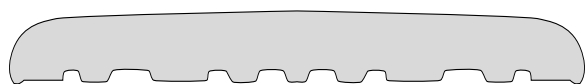

Cubierta para capó



protector de la defensa x2



Soporte x 4



Tornillo autorroscante x 2

Herramientas necesarias



Equipo de limpieza de vehículos

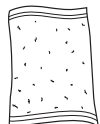

Toalla limpia

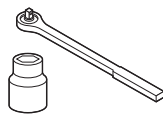

Llave De Zócalo

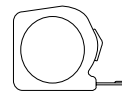

Cinta Que mide

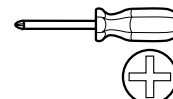

Destornillador Phillips

Preparación antes de pintar o instalar

- Se recomienda realizar un ajuste de prueba para asegurar el posicionamiento y ajuste correctos.
- Compruebe que las piezas se ajusten correctamente antes de pintarlas, ya que no aceptaremos la devolución de piezas modificadas o pintadas.
- Lave los canales de la ventanilla del vehículo para quitar los desechos y la suciedad.
- Seque los canales de la ventanilla con una toalla limpia.

Pasos de instalación

NOTA: El uso real puede variar levemente de ilustraciones.

Abra el capó.

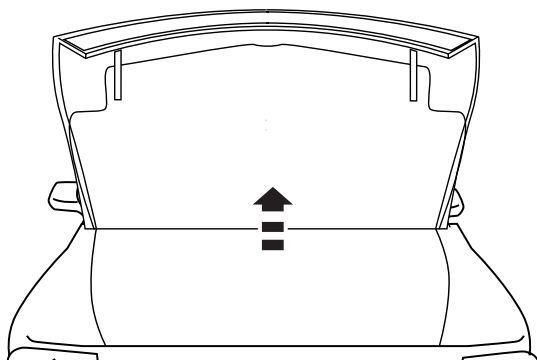

1



Ubique el marco que se une al capó. Afloje pero no quite los (4) tornillos hexagonales que se unen a la parte inferior del capó.

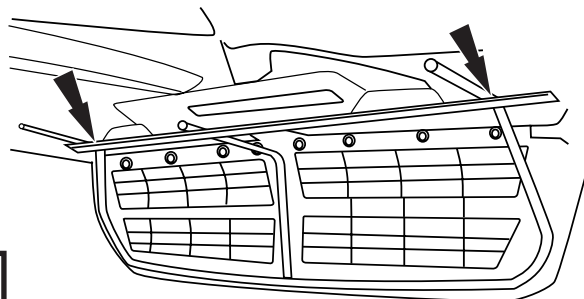

2

Pasos de instalación

NOTA: El uso real puede variar levemente de ilustraciones.



Ubique los tornillos hexagonales que unen la parte superior de la parrilla al capó. Afloje los tornillos, pero no los quite completamente.

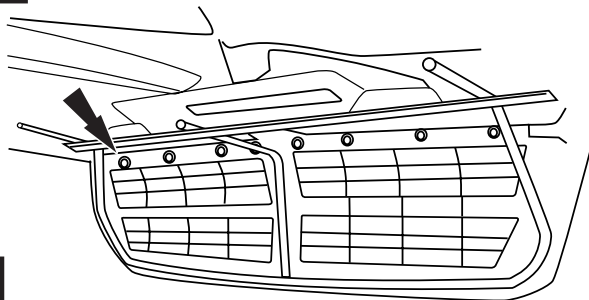

3

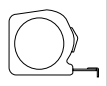

Baje el capó y gire la parrilla hacia adelante para generar un espacio de 1/8" (3 mm) entre el capó y la parrilla.

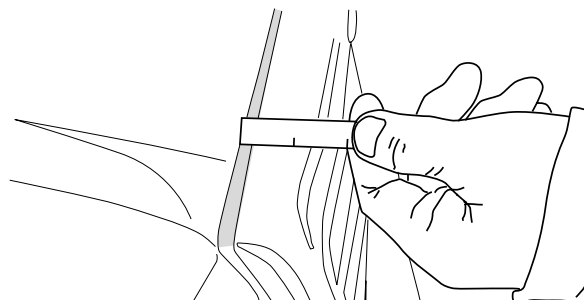

4

Deslice la cubierta para capó en el espacio entre el capó y la parrilla hasta que esté correctamente colocada. Vuelva a ajustar los tornillos hexagonales que había aflojado anteriormente.

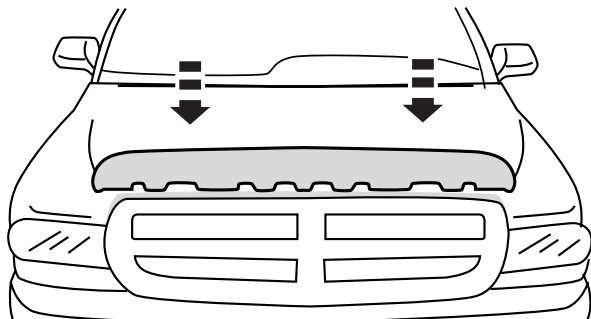

5

Instalación del protector de guardabarros

Coloque (1) soporte sobre el borde delantero del guardabarros por encima del faro a 9" (23 cm) del borde de la parrilla.

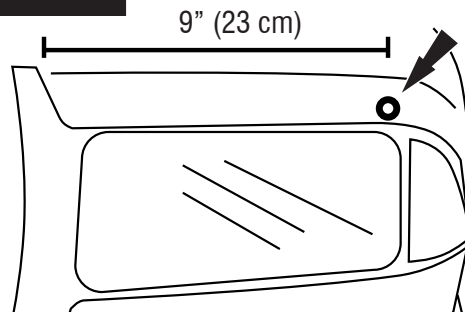

6

Exponga la lámina de metal del capó; para ello, separe la junta de goma más cercana a la parrilla. Deseche el sujetador de plástico.

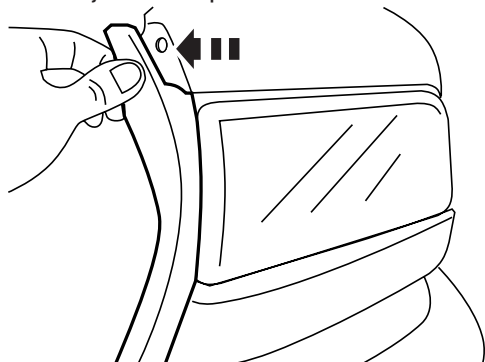

7

Deslice la lengüeta protectora detrás del conjunto principal; para ello, incline mientras está alineado con el espacio entre la luz indicadora lateral y el conjunto del faro principal.

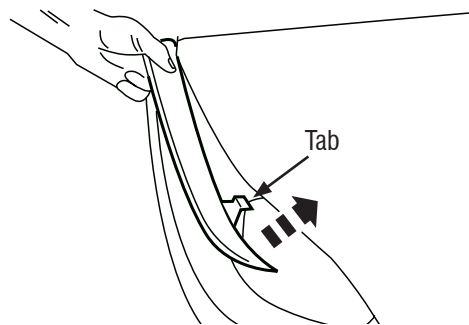

8

Alinee el orificio del protector marcado para taladrar con el orificio de la lámina de metal; para ello, deslice el reborde entre el reborde de goma y el de metal.

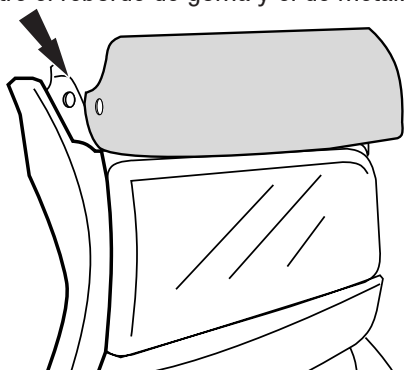

9

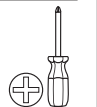

El tornillo autorroscante reemplaza al sujetador desechado anteriormente. Fije el deflector y la junta de goma al reborde de la lámina de metal con este tornillo.

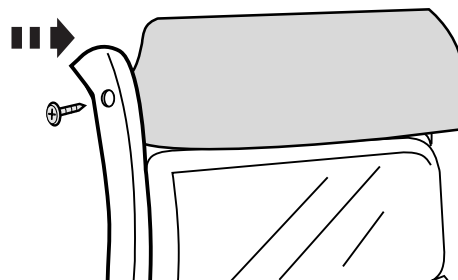

10

NO AJUSTE DEMASIADO

Pasos de instalación

NOTA: El uso real puede variar levemente de ilustraciones.

Repita el procedimiento para el protector de guardabarros del otro lado del vehículo.

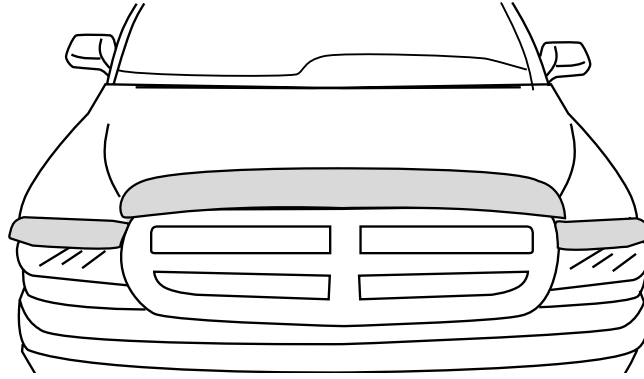

11

Cuidado y limpieza

- Limpie solamente con agua jabonosa tibia y seque con un paño limpio.

Felicidades

Usted ha comprado uno de los tantos artículos de calidad de Auto Ventshade™ ofrecidos por Lund International, Inc. Nuestros productos son nuestro mayor orgullo. Deseamos que disfrute de años de satisfacción con su inversión. Hemos realizado todos los esfuerzos para asegurarnos de que su producto sea de la mejor calidad en cuanto a ajuste, durabilidad, acabado y facilidad de instalación.



Lund International

800-241-7219 • Visite nuestro sitio Web: lundinternational.com

© 2012 Lund International, Inc. Todos los derechos reservados.



Auto Ventshade™, el logo de Auto Ventshade™ y el logo de AVS™ son marcas comerciales de Lund International, Inc.

