

Installation Instructions

I - Sheet Number BF75 Rev.A



Bugflector® - Bugflector II® - Carflector® - Chrome Hood Shield™

For proper installation and best possible fit, please read all instructions BEFORE you begin.
For technical assistance or to obtain missing parts, please call Customer Relations at 1-800-241-7219.

Important Safety Information



- CAUTION - Before driving, ensure that the hood shield is properly anchored to vehicle.
- Do not use automatic "brush-style" car washes.
- Do not use cleaning solvents of any kind.
- Periodically check all components for tightness.

Contents **NOTE:** Actual product may vary from illustration.

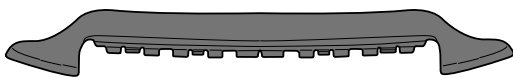

Hood Shield



Screw x2



Washer x2



Bump On x4

Tools Required



Car Wash Supplies

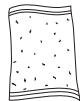

Clean Towel

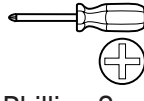

Phillips Screw
Driver

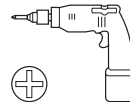

Drill



Ratchet or Wrench

Preparation Before Painting / Installation

- A trial fit is recommended to ensure proper positioning and fit.
- Check fit of parts before painting as we will not accept the return of modified or painted parts.
- Wash your vehicle's hood to remove any debris and/or dirt.
- Dry the hood with a clean towel.

Installation Steps **NOTE:** Actual application may vary slightly from illustrations.



Open hood and remove (2) 8mm hex head screws located at the bottom of the metal grille brace on either side of the grille. Retain screws for later reinstallation.

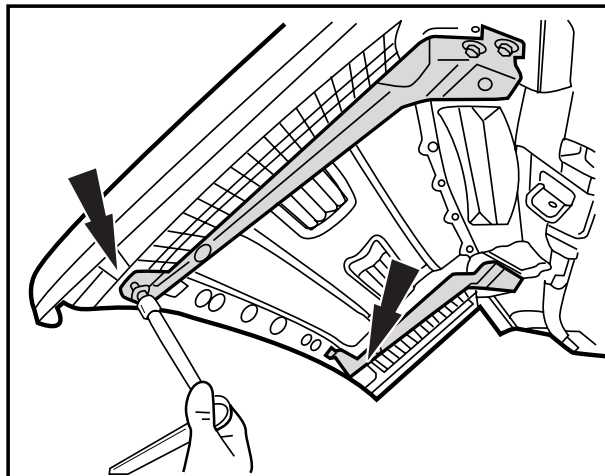

Remove 8mm hex
screws

1

Installation Steps

NOTE: Actual application may vary slightly from drawings.

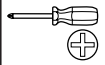

Bring hood back down to a semi-closed position. Remove (7) grille retaining fasteners with a #2 phillips screwdriver. Retain fasteners for later reinstallation.

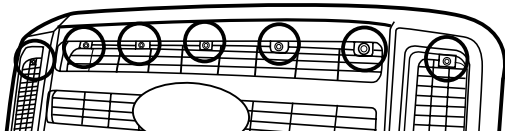
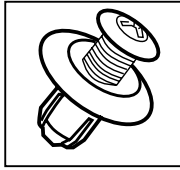

3

NOTE: It may be necessary to squeeze the back side of these retainers by hand to help the screw back out of the fastener base.

Carefully remove grille by grasping the top and bottom of one side and gently pulling upwards. This will disengage the top underside retention clips. Repeat the same procedure for the opposite side. The grille will need to be completely removed and placed carefully aside to avoid any possible damage. Clean this newly exposed area of the hood.

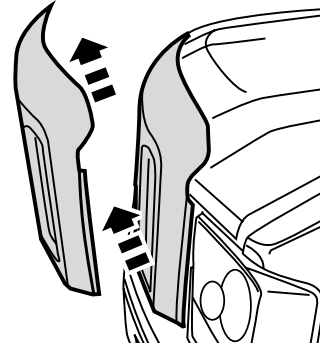

4

Remove hood shield from packaging, fit hood shield onto hood at the wing mounting tabs first and then the center. Ensure the wing tabs are located on the underside of the hood and that the center mounting tab cut outs do not block the existing hood holes. Make sure that the hood shield is centrally located on the hood.

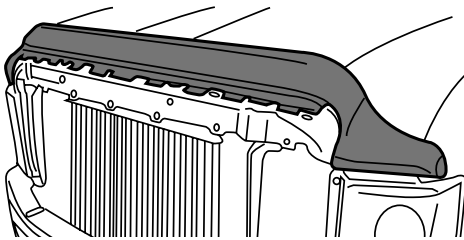
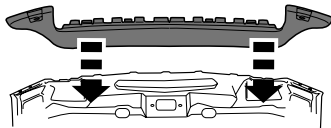

5

Re-install the grille onto the hood, making sure that the protruding mounting points on the grille line up with the receiving holes in the hood.

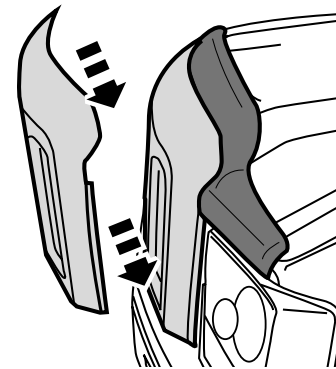

6

NOTE: the grille will not completely snap back into these mountings as the thickness of the product will now hold it off slightly.

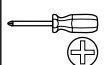

Reinstall the previously removed (7) fasteners back into the grille to ensure that it is being securely held in place.

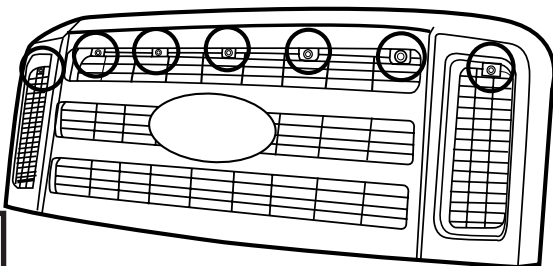
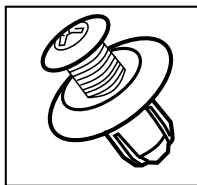

7

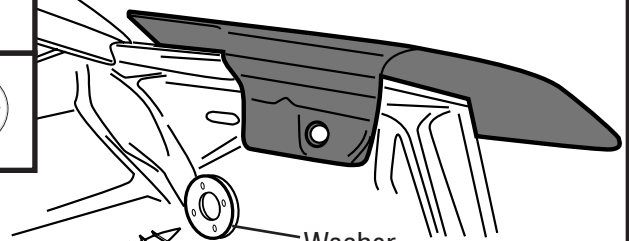
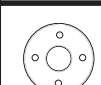
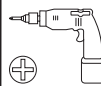

Washer

Screw

8

NOTE: Do not over tighten.

Installation Steps

NOTE: Actual application may vary slightly from drawings.



Re-install the previously removed (2) 8mm hex head screws back into the bottom of the metal grille brace on either side of the grille.
Close hood.

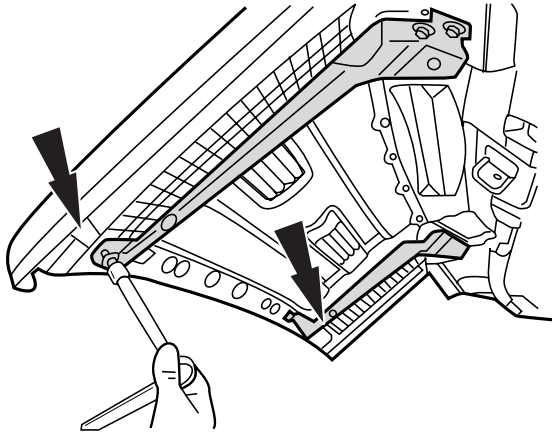

9



Install (4) bump ons.

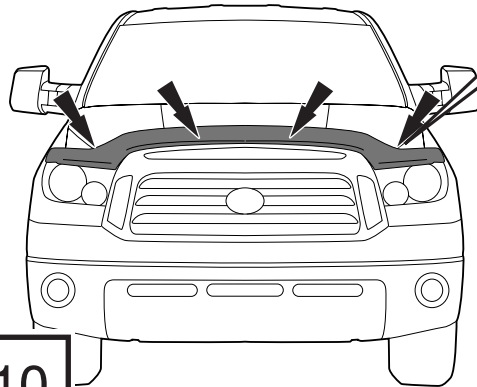

10

Care and Cleaning

- Wash only with mild soap & dry with a clean cloth.

Congratulations!

You have purchased one of the many quality Auto Ventshade™ branded products offered by Lund International, Inc. We take the utmost pride in our products and want you to enjoy years of satisfaction from your investment. We have made every effort to ensure that your product is top quality in terms of fit, durability, finish and ease of installation.



AUTO VENTSHADE™

Lund International, Ventshade Accessories Division

655 Raco Drive, Lawrenceville, GA 30045

800-241-7219 • Fax 770-339-5839 • Visit us at lundinternational.com

© 2007 Lund International, Inc. All rights reserved.

Auto Ventshade™, the Auto Ventshade™ logo and the AVS™ logo are trademarks of Lund International, Inc.



Instructions d'installation

I – Feuille numéro BF75 Rév.A



Bugflector® - Bugflector II® - Carflector® - Chrome Hood Shield™

Pour obtenir une installation correcte et le meilleur ajustement possible, lire toutes les instructions AVANT de commencer.
Pour toute assistance technique ou obtention de pièces manquantes, appeler le service des relations avec la clientèle au 1-800-241-7219.

Informations importantes concernant la sécurité



- ATTENTION - Avant de conduire, s'assurer que le pare-insectes est solidement assujéti sur le véhicule.
- Ne pas utiliser les stations de lavage de voitures à brosses.
- Ne pas utiliser de solvants.
- Vérifier régulièrement le serrage des composants..

Contenu **NOTE:** Le produit réel peut changer de l'illustration.

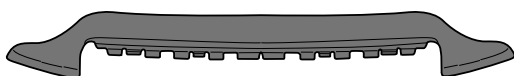

Pare-insectes



Vis taraudeuses (2)



Rondelles (2)



Butoirs (4)

Outils nécessaires



Fournitures pour lavage de voiture



Serviette propre

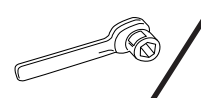
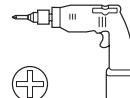
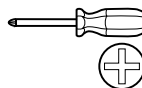

Outils à main appropriés

Préparation pour la peinture/l'installation

- Il est recommandé de procéder à un essai pour s'assurer que le positionnement et l'ajustement sont corrects.
- Vérifier l'ajustement des pièces avant peinture, car nous n'acceptons pas le retour de pièces modifiées ou peintes.
- Laver le véhicule pour éliminer toute poussière et tous débris.
- Sécher le capot avec une serviette propre.

Étapes d'installation **REMARQUE:** La méthode d'application peut être légèrement différente de celle représentée par les illustrations.



Ouvrez le capot et ôtez les (2) vis à tête hexagonale de 8 mm situées au bas du renfort métallique, de part et d'autre de la calandre. Conservez les vis afin de pouvoir les réinstaller ultérieurement.

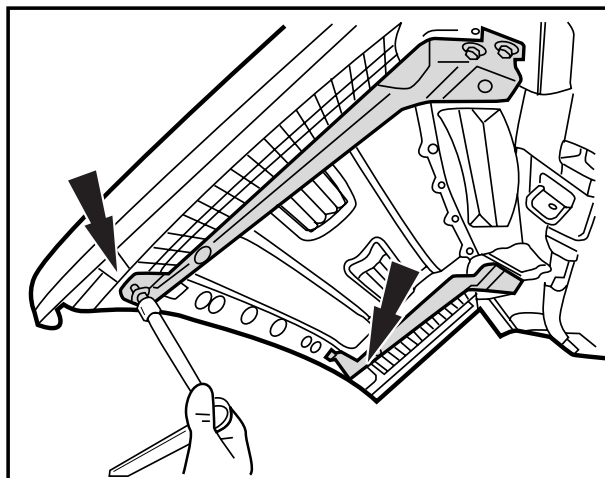

Ôtez les vis à tête hexagonale de 8 mm

1

Étapes d'installation

REMARQUE : La méthode d'application peut être légèrement différente de celle représentée par les illustrations.

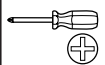

Fermez le capot à moitié. Ôtez les (7) attaches fixant la calandre à l'aide d'un tournevis à pointe cruciforme n°2. Conservez les attaches afin de pouvoir les réinstaller ultérieurement.

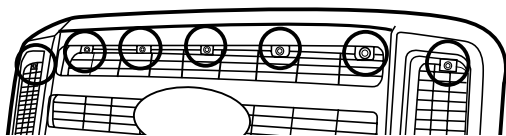
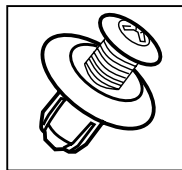

REMARQUE : Vous devrez peut-être exercer une pression manuelle sur la partie arrière de ces attaches afin de dégager plus facilement la vis de la base de l'attache.

3

Retirez soigneusement la calandre en saisissant les parties supérieure et inférieure de son côté gauche et en les soulevant doucement vers le haut. Vous libérerez ainsi les attaches situées en haut, sous la calandre. Procédez de même pour le côté droit. La calandre devra être retirée complètement, puis entreposée à un endroit sûr afin d'éviter tout dégât. Nettoyez la partie du capot que vous venez d'exposer.

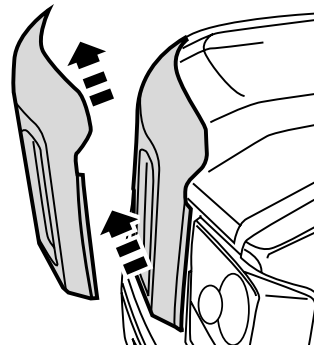

4

Sortez la protection de capot de son emballage, placez-la sur le capot. Commencez par enclencher les pattes de fixation des ailes, puis fixez celles du centre. Veillez à ce que les pattes de fixation des ailes soient bien situées sous le capot et que les pattes de fixation centrales ne recouvrent pas les trous du capot. Assurez-vous que la protection de capot est bien centrée sur le capot.

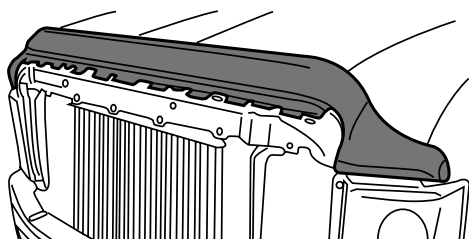
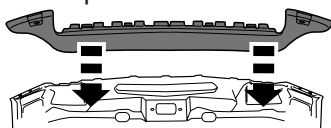

5

Réinstallez la calandre sur le capot, en veillant à ce que les points de fixation de cette dernière soient bien alignés avec les trous correspondants du capot.

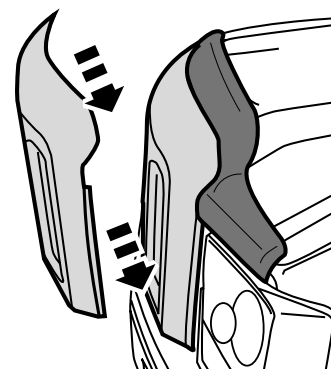

6

REMARQUE : La calandre ne se refermera pas parfaitement sur ces fixations en raison de l'épaisseur de la protection.

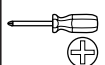

Réinstallez les (7) attaches que vous aviez ôtées sur la calandre afin qu'elle soit fermement maintenue en place.

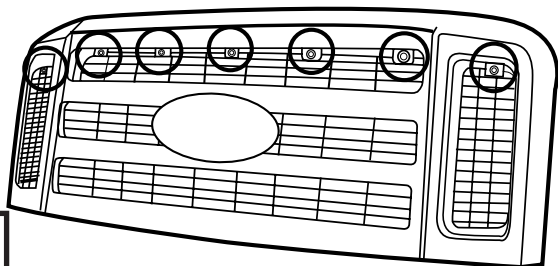
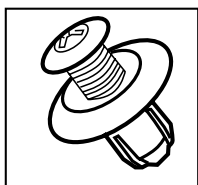

7



Ouvrez prudemment le capot et installez les vis et les rondelles au niveau des fixations de l'aile pour attacher la protection de capot au capot.

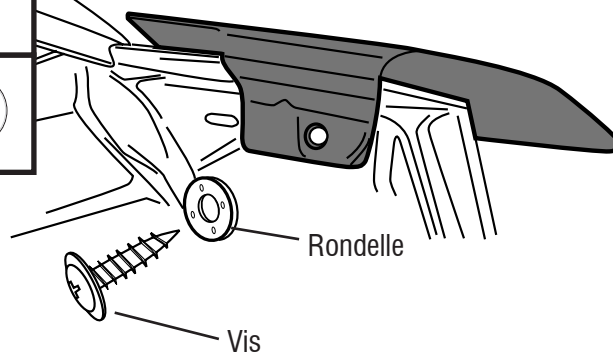
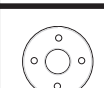

8

REMARQUE : Ne les serrez pas trop fort.

Étapes d'installation

REMARQUE : La méthode d'application peut être légèrement différente de celle représentée par les illustrations.



Réinstallez les (2) vis à tête hexagonale de 8 mm que vous aviez ôtées au bas du renfort métallique, de part et d'autre de la calandre. Fermez le capot.

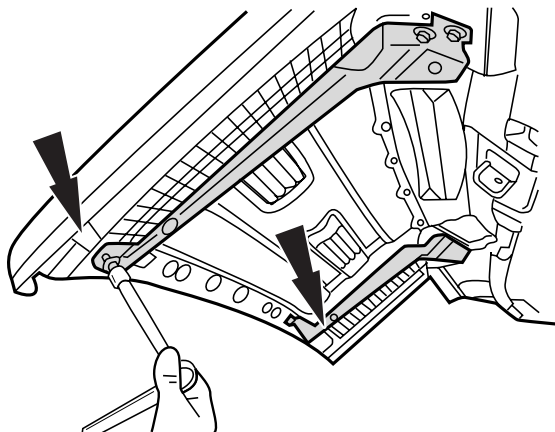

9



Installez les (4) dispositifs de protection.

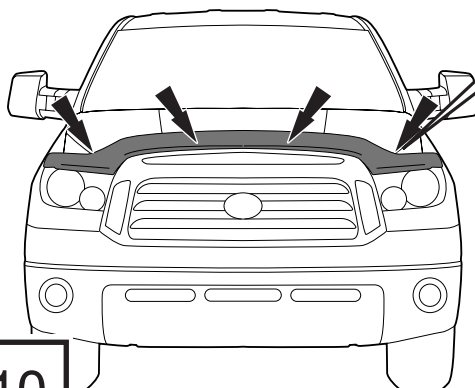

10

Entretien et nettoyage

- Laver exclusivement avec de l'eau savonneuse et sécher avec un chiffon propre.

Félicitations !

Vous avez acheté l'un des nombreux produits de qualité Auto Ventshade™ fabriqués par Lund International, Inc. Nous sommes extrêmement fiers de nos produits et souhaitons que vous tiriez des années de satisfaction de votre investissement. Nous avons pris toutes les mesures nécessaires pour assurer que ce produit est d'une qualité supérieure en ce qui concerne l'ajustement, la durabilité, la finition et la facilité d'installation.



AUTO VENTSHADE™

Lund International, Ventshade Accessories Division
655 Raco Drive, Lawrenceville, GA 30045, USA

800-241-7219 • Fax 770-339-5839 • Visitez notre site lundinternational.com

© 2007 Lund International, Inc. Tous droits réservés.



Auto Ventshade™ le logo Auto Ventshade™, Chromeflector™ et le logo AVS™ sont des marques déposées de Lund International, Inc.



Instrucciones de instalación

Hoja informativa N.º BF75 Rev. A



Bugflector® - Bugflector II® - Carflector® - Chrome Hood Shield™

Para una instalación adecuada y el mejor ajuste posible, lea todas las instrucciones ANTES de comenzar. Si desea recibir asistencia técnica u obtener piezas faltantes, llame al Servicio al cliente al 1-800-241-7219.

Información importante de seguridad



- PRECAUCIÓN - Antes de conducir, asegúrese de que la cubierta para capó esté correctamente anclada al vehículo.
- No utilice servicios automáticos de limpieza de vehículos que utilizan cepillos.
- No utilice limpiadores al solvente de ningún tipo.
- Compruebe periódicamente que todos los componentes estén ajustados.

Contenido NOTA: El producto real puede variar de la ilustración.

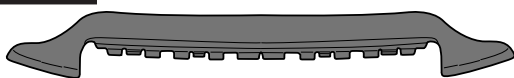

Cubierta para capó



Tornillo autorroscante x 2



Arandela x 2



Soporte x 4

Herramientas necesarias



Equipo de limpieza de vehículos



Toalla limpia

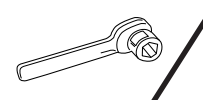
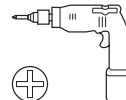
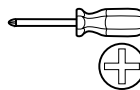

Herramientas manuales adecuadas

Preparación antes de pintar o instalar

- Se recomienda realizar un ajuste de prueba para asegurar el posicionamiento y ajuste correctos.
- Compruebe que las piezas se ajusten correctamente antes de pintarlas, ya que no aceptaremos la devolución de piezas modificadas o pintadas.
- Lave el capó del vehículo para quitar los desechos y la suciedad.
- Seque el capó con una toalla limpia.

Pasos de instalación NOTA: El uso real puede variar levemente de ilustraciones.



Abra el capó y retire los (2) tornillos de 8 mm de cabeza hexagonal ubicados en el fondo de la abrazadera de la rejilla metálica en cada lado de ésta. Conserve estos tornillos para reinstalar la pieza más tarde.

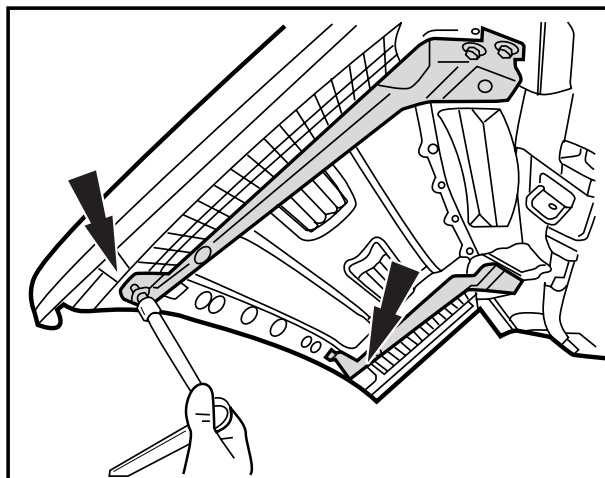

Retire los tornillos 8 mm de cabeza hexagonal

1

Pasos de instalación

AVISO: La colocación real puede variar levemente con respecto a las ilustraciones.

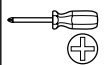

Baje el capó hasta una posición semi cerrada.
Retire los (7) broches de la rejilla con un destornillador de cabeza Phillips No. 2. Conserve estos broches para reinstalar la pieza más tarde.

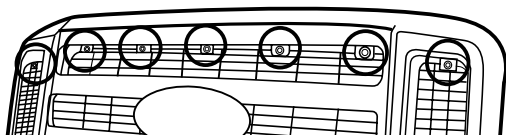
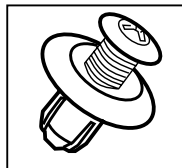

NOTA: tal vez tenga que apretar la parte trasera de los retenedores con la mano para ayudar a que el tornillo salga de la base del broche.

3

Retire cuidadosamente la rejilla tomándola de un lado por la parte superior e inferior y tirando suavemente hacia arriba. De esta manera se desacoplarán los clips de retención de la parte inferior de arriba. Repita este mismo procedimiento en el lado opuesto. La rejilla debe retirarse completamente y colocarse a un lado con cuidado para evitar cualquier daño. Limpie esta área del capó.

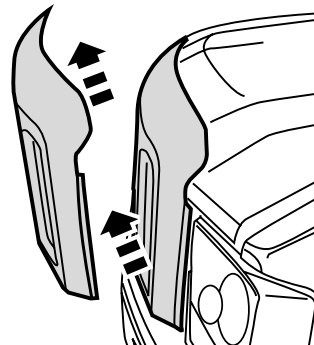

4

Retire el escudo del capó de la caja y acóplelo en el capó de manera que las lengüetas de montaje de los costados entren primero y luego las del centro. Asegúrese de ubicar las del costado en la parte inferior del capó y que los cortes de la lengüeta central no bloqueen los agujeros del capó existentes. Cerciérese de que el escudo quede en el centro del capó.

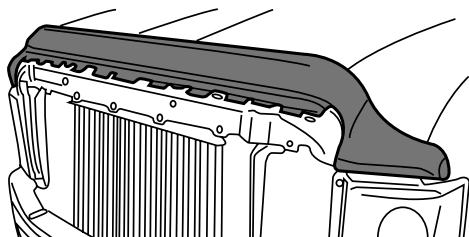
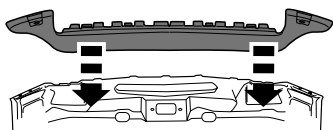

5

Reinstale la rejilla en el capó, tomando en cuenta que los salientes de montaje en la rejilla estén alineados con los agujeros en el capó.

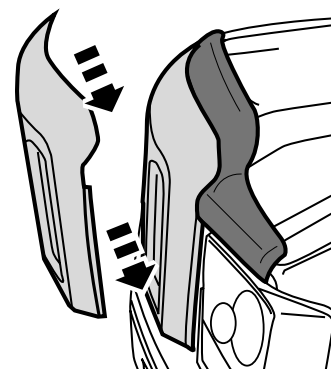

NOTA: la rejilla no calzará a presión completamente en estos montajes debido a que el espesor del producto ofrecerá algo de resistencia.

6

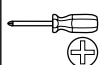

Coloque de nuevo los (7) broches en la rejilla para asegurarse de que quede bien fija.

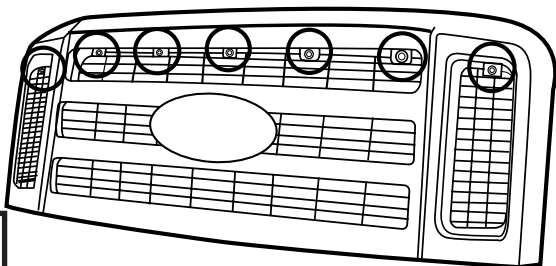
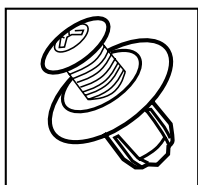

7

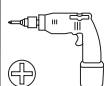

Abra con cuidado el capó e instale los tornillos y arandelas en las lengüetas del costado exterior para fijar el escudo al capó.

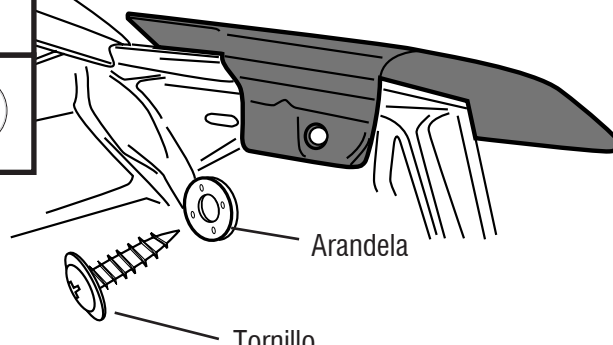
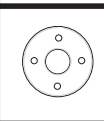

NOTA: no ajuste con demasiada fuerza.

8

Pasos de instalación

AVISO: La colocación real puede variar levemente con respecto a las ilustraciones.



Fije de nuevo los (2) tornillos de 8 mm de cabeza hexagonal en el fondo de la abrazadera de la rejilla metálica en cada lado de ésta. Cierre el capó.

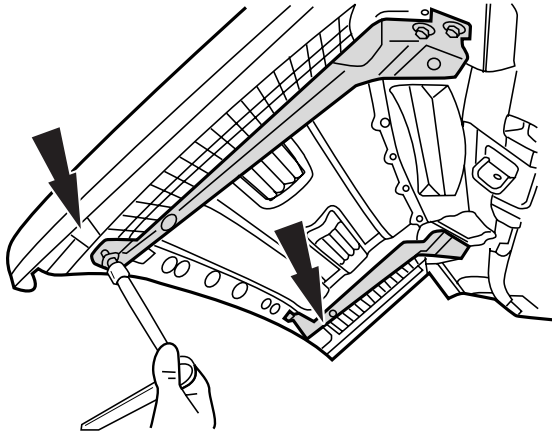

9



Instale (4) soporte.

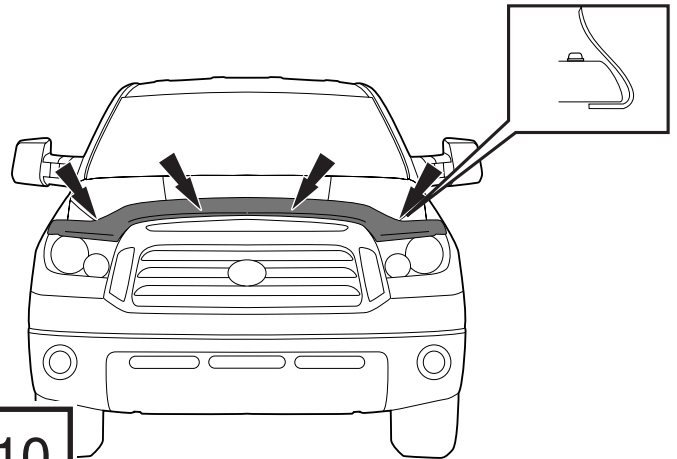

10

Cuidado y limpieza

- Limpie solamente con agua jabonosa tibia y seque con un paño limpio.

Felicidades

Usted ha comprado uno de los tantos artículos de calidad de Auto Ventshade™ ofrecidos por Lund International, Inc. Nuestros productos son nuestro mayor orgullo. Deseamos que disfrute de años de satisfacción con su inversión. Hemos realizado todos los esfuerzos para asegurarnos de que su producto sea de la mejor calidad en cuanto a ajuste, durabilidad, acabado y facilidad de instalación.



AUTO VENTSHADE™

Lund International, Ventshade Accessories Division

655 Raco Drive, Lawrenceville, GA 30045

800-241-7219 • Fax 770-339-5839 • Visite nuestro sitio Web: lundinternational.com

© 2007 Lund International, Inc. Todos los derechos reservados.



™ Auto Ventshade™ el logo de Auto Ventshade™, Chromeflector™ y el logo de AVS™ son marcas comerciales de Lund International, Inc.

